



# Construction Safety nets

You can rely on HUCK safety nets!



CONSTRUCTION SAFETY NETS

2019/2020



Testing a net

Whether in our daily work routine, leisure time, sporting activities or in traffic – we are confronted with obvious or hidden risks in many areas.

For many years now the HUCK company has been tasked with the challenge of minimising some of these risks with the most varied of net products.

To this end we invest in research and development, quality assurance and testing as well as cooperate in diverse standardisation committees and working groups for trade associations for the building industry.

External quality control keep our business premises in check and product testing by BG-Bau, DGUV-Test, TÜV and Dekra have earned us many quality marks which characterise our nets.

Alongside the GS mark, the DGUVTest mark, Dekra label and TÜV ISO 9001 Certification, this year sees the addition of the new ET mark (EuroTest). EuroTest is a voluntary type testing which is based on the EC directive and the associated European norms. BG Bau is the institute carrying the EuroTest mark.

## 55 years of HUCK

... means 55 years of entrepreneurial spirit and HUCK's focus on quality  
... means 55 years of development in net technology  
... means a good many professional careers.



Dear Business Colleagues,

Please find enclosed the new HUCK-Building Protection Catalogue 2019/2020. Building protection nets are generally safety nets EN 1263-1, which have the task of catching falling people.

We differentiate here between the horizontal safety nets and vertical guardrail nets or vertical safety nets used in scaffolding.

The use of horizontal fall arrest nets in Germany is governed by DGUV-Regulation 101-011. A company must ensure that the life and health of their staff is not endangered or is kept to a minimum on a building site. Collective measures take precedence over individual protective measures. One option of a collective protective measure here is the use of safety net systems.

Horizontal fall arrest safety nets are extensive safety nets EN 1263-1 System S (Net with rope edging) and System T (Net in consoles for horizontal use).

In Germany the DGUV-Regulation 201-023 in turn governs the use of vertical guardrail nets in side protection and in protective walls as means of fall protection in construction work.

The DGUV-Regel 201-023 also governs the element of protection on the edge of the roof outside when side protection is not possible on the building site. Protective net systems can also be used here.

In addition there are many other applications for safety nets, mainly to protect people from falling objects.

We hope that you find a product that is suitable for you. We are happy to advise you and hear your suggestions.

Kind Regards

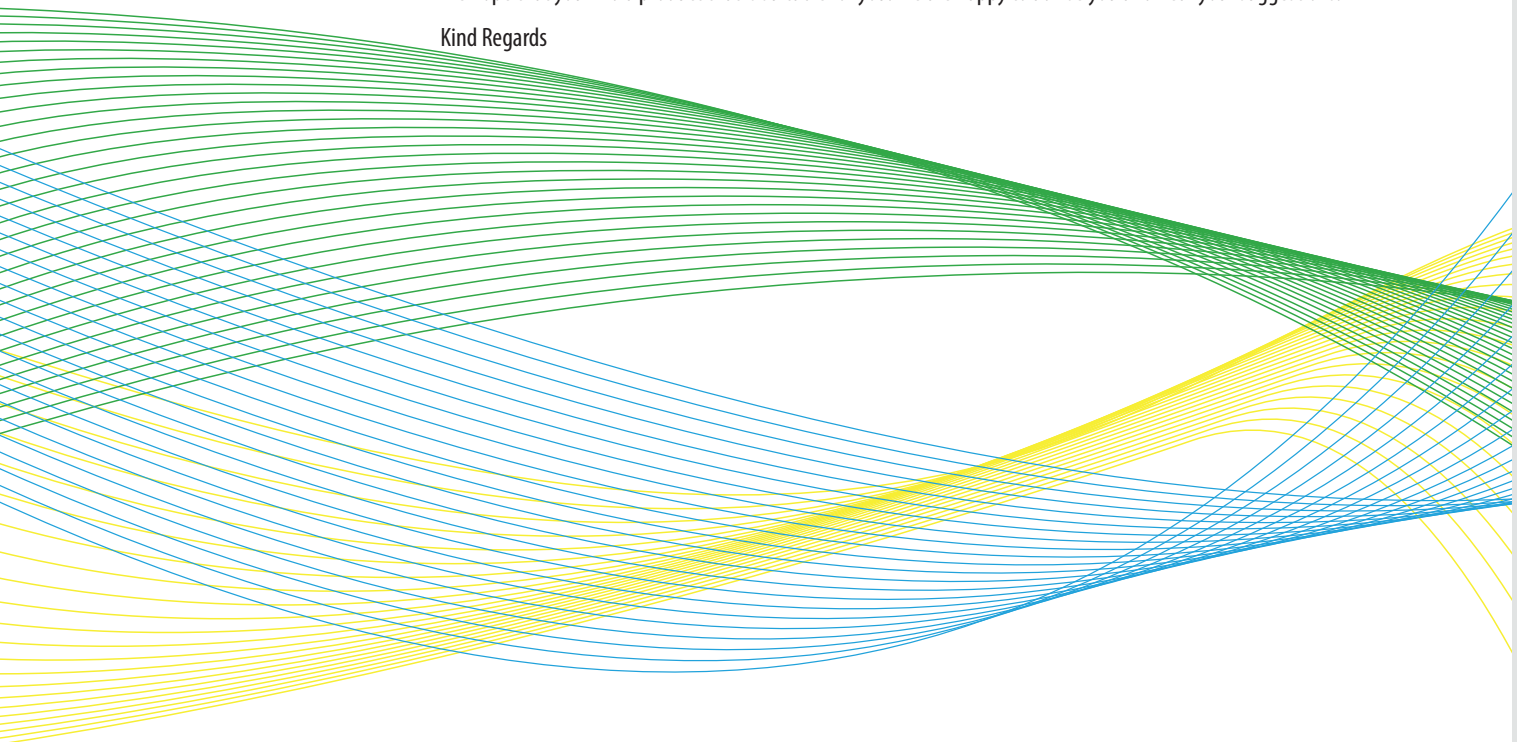

# Contents

## SAFETY NETS

5 – 25

Square mesh	6–8
Diamond mesh	9
Complete packages	10
Overlay nets and panels	11–13
Netting suspension	14–16
Fall protection / Dome light safety system	17
Fall Arrest Safety Renting	18
Safety-net assembly	19
Safety-net installation information	20–21
Fax request form	22
Small Nets	23
Nets as work platforms	24–25

## BRICK GUARDRAIL NETS

26 – 38

With Isilink clips in standard sizes	26–27
In standard sizes without Isilink clips	28–29
In all sizes without Isilink clips with buckled straps in standard sizes	30
Ready-made net-protection walls	31
Side-protection netting	32–33
Side-protection panels	34
Scaffold-protection netting / dust-protection nets	35
Dust-protection net / Tarpaulins	36–37
Brick guardrail nets – safety information	38

## SAFETY AND INDUSTRIAL NETS

39 – 45

Technical details	39
Specifications	40–41
Material thickness from 1 to 3 mm	42
Material thickness from 3.5 to 6 mm	43
Standard sizes/accessories	44
Accessories	45

## SAFETY NETS FOR SPECIAL APPLICATIONS

46 – 55

Pallet-rack nets	46
Assembly instructions on small safety nets	47
For special applications	48
Lifting loads	49–50
Securing loads	51–52
“Powernet” for overhead cable construction	53
Dralo® wire-rope nets /Wire-rope nets Type “DRALO Xtreme”	54–55

## ROPES AND COVERS

56 – 60

Ropes for the industrial and construction sector	56–57
Impermeable tarpaulins	58
Air-permeable nets/covers	59
Building-site fencing/Site fence screen	60

## INFORMATION

61

Terms and conditions of sale	61
More Huck products	62
Index / Contacts	U 3

### The advantages of safety nets

- Unlike PPE equipment, they allow workers to move freely.
- They provide collective protection for all work and transportation in the secured area.
- Should anyone fall, the net provides a softer landing than rope equipment, thanks to its energy-absorption characteristics.

**Applicable standards, rules and laws.** The occupational health and safety act forms the legal basis for occupational health and safety. This in turn is shaped by accident prevention provisions. The use of fall arrest nets is laid down in the DGUV-R-101-011. The product norm for fall arrest nets is EN 1263-1. Only fall arrest nets which comply with this norm are permissible products under the DGUV-R-101-011 and are therefore permitted for fall protection in the sense of the occupational health and safety act and accident prevention provisions.

### HUCK safety nets with safety margin

In the static-energy-absorption test, a 3 x 3 m test net with a minimum safety factor of 1.5 must have an ageing reserve of at least one year. HUCK safety nets have an even greater margin and therefore offer the greatest possible safety.

### HUCK quality management

All the safety nets shown in this catalogue undergo regular checks from our quality management. Both the HUCK company and our quality management are ISO 9001 certified.



## System-S safety nets conforming to EN 1263-1

Safety nets are horizontally erected guard nets with rope threaded into the edges of the mesh. The exact definition of this type of rope-edged safety net is system-S safety net conforming to EN 1263-1. The system-S category is further divided into four classes of net, based on their minimum breaking strength. These have to meet the following requirements:

- a) minimum strength of rope edge: 30 kN;
- b) maximum mesh size: 60 mm or 100 mm;
- c) minimum energy absorption of a  $3 \times 3$  m test net (see table and example).

**The most important classification factor is the minimum energy absorption when new, including the safety factor and the individual ageing factor\*\*** (see table and example).

A new safety net must have an ageing factor of at least one year. This means that, in the example given for net class A2, the minimum energy absorption when new is at least 4.14 kJ.

There are four classes of net altogether:

Net class	Minimum breaking strength	Safety factor	Ageing factor	Maximum net size
<b>A1</b>	2.3 kJ	1.5	individual	60 mm
<b>A2</b>	2.3 kJ	1.5	individual	100 mm
<b>B1</b>	4.4 kJ	1.5	individual	60 mm
<b>B2</b>	4.4 kJ	1.5	individual	100 mm

<b>** Example for net class A2</b>	Minimum breaking strength	×	Safety factor	=	Energy absorption without ageing	×	Ageing factor	=	Minimum energy absorption when new
	2.3 kJ	×	1.5	=	3.45 kJ	×	1.2 (e.g.)	=	4.14 kJ

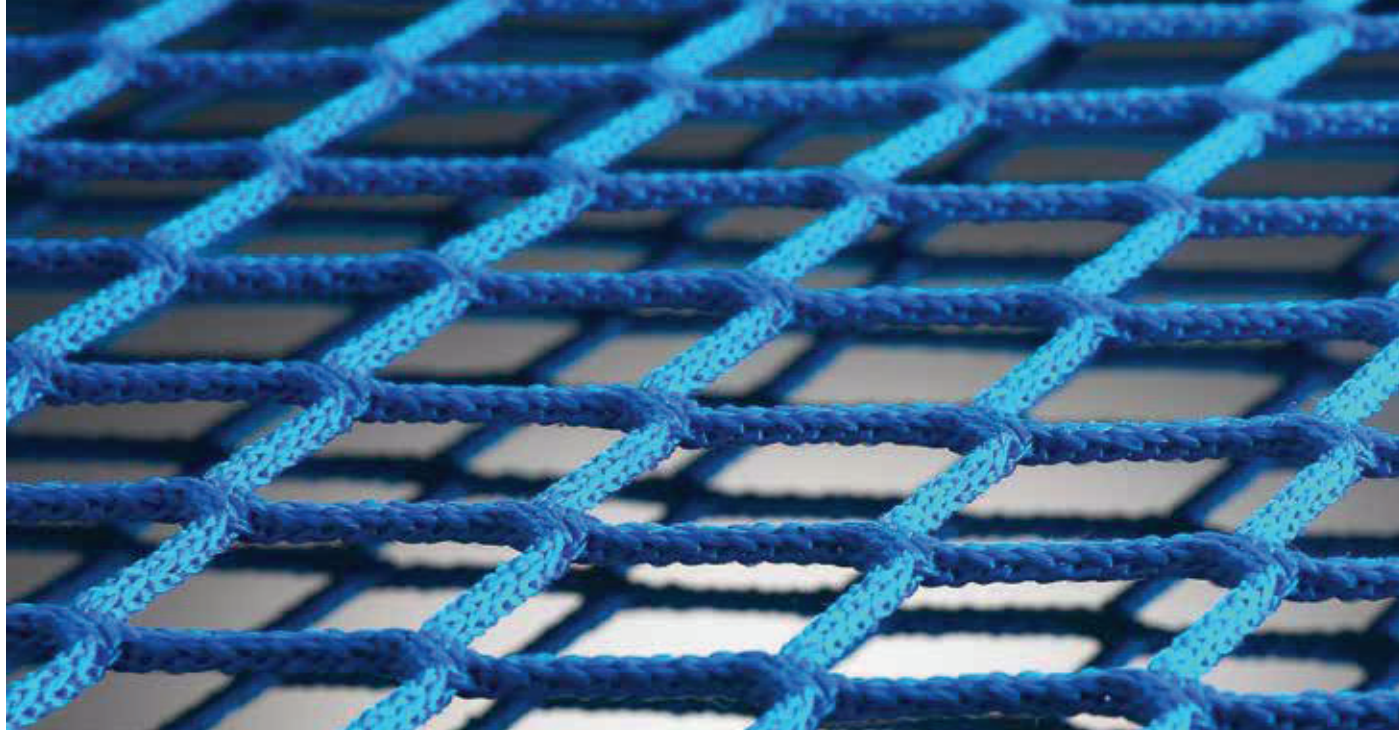

## Safety nets edged all round with rope

• Square Mesh •

### Any size

*Description:* Knotless system-S safety net conforming to EN 1263-1 (rope-edged safety net) in approx. 5 mm high-tenacity polypropylene. Square mesh, edged all round with approx. 12 mm, 30-kN rope.

### Standard sizes

*Description:* Knotless system-S safety net conforming to EN 1263-1 (rope-edged safety net) in approx. 4.75 mm high-tenacity polypropylene. Square mesh, edged all round with approx. 12 mm, 30-kN rope.

Energy absorption approx. 4.6 kJ. Net class A2. GS test certificate : PS-no. .18100015

Mesh size	Energy absorption	Colours	GS test certificate	Art.-No.	Price / m <sup>2</sup>
100 mm	app. 4.8 kJ = Net cl. A2	<ul style="list-style-type: none"> <li>● Green</li> <li>○ White</li> <li>● Orange</li> <li>● Blue</li> <li>● Yellow</li> <li>● Black</li> <li>● Red</li> <li>● Hemp</li> </ul>	PS-no. 18100013	1903-100	
60 mm	app. 6.1 kJ = Net cl. A1	<ul style="list-style-type: none"> <li>● Green</li> <li>● Blue</li> <li>● Red</li> </ul>	PS-no. 18100012	1903-060	
45 mm	app. 9 kJ = Net cl. B1	<ul style="list-style-type: none"> <li>● Green</li> <li>○ White</li> <li>● Blue</li> <li>● Black</li> <li>● Red</li> <li>● Hemp</li> </ul>	PS-no. 18100010	1903-045	

Mesh size	Colours	Size	Art.-No.	Price / each
100 mm	<ul style="list-style-type: none"> <li>● Green</li> <li>● Blue</li> </ul>	5 × 10 m	19040-100	
100 mm	<ul style="list-style-type: none"> <li>● Green</li> <li>● Blue</li> </ul>	6 × 10 m	19041-100	
100 mm	<ul style="list-style-type: none"> <li>● Green</li> <li>● Blue</li> </ul>	10 × 10 m	19042-100	
100 mm	<ul style="list-style-type: none"> <li>● Green</li> <li>● Blue</li> </ul>	7.50 × 15 m	19043-100	

- = 01 = green
- = 03 = orange
- = 06 = black
- = 015 = dark green
- = 04 = blue
- = 07 = red
- = 02 = white
- = 05 = yellow
- = 08 = hemp

Example of product number 1903-100-07  
 Specification    Mesh size    Colour

### Surcharge for small quantities:

Nets under 1 m<sup>2</sup>: upon request  
 Nets under 5 m<sup>2</sup> + 100% per net  
 Nets under 10 m<sup>2</sup> + 35% per net  
 Nets under 20 m<sup>2</sup> + 20% per net

*The surcharge is based on the size of a single net, and not on the total order.*

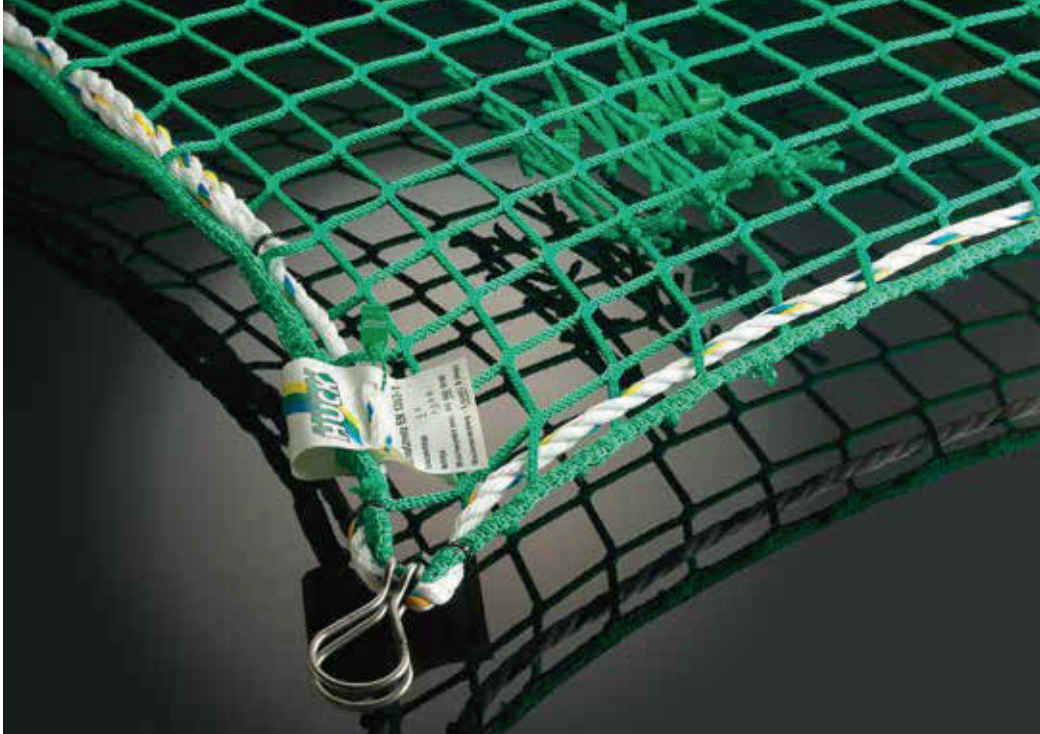

Net with metal thimble (no. 2021).

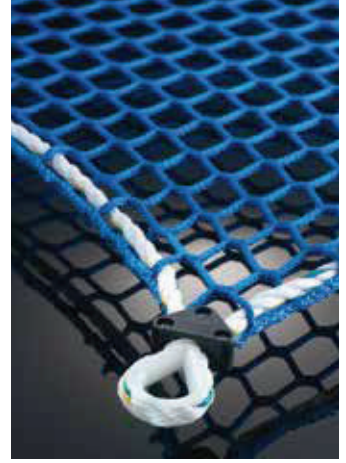

Net with plastic thimble (no. 2017).

## Safety nets with rope edging all round and thimbles

• Square Mesh •

### every 2.5 m - any size

*Description:* Knotless system-S safety net conforming to EN 1263-1 (rope-edged safety net) in approx. 5 mm high-tenacity polypropylene. Square mesh, edged all round with approx. 12 mm, 30-kN rope and with thimbles every 2.50 m.

Mesh size	Energy-absorption	Colours*	GS test certificate	Art.-No.	Price / m <sup>2</sup>
100 mm	app. 4.8 kJ = Net cl. A2	<ul style="list-style-type: none"> <li>● Green</li> <li>○ White</li> <li>● Orange</li> <li>● Blue</li> <li>● Yellow</li> <li>● Black</li> <li>● Red</li> <li>● Hemp</li> </ul>	PS-no. 18100013	2003-100	
60 mm	app. 6.1 kJ = Net cl. A1	<ul style="list-style-type: none"> <li>● Green</li> <li>● Blue</li> <li>● Red</li> </ul>	PS-no. 18100012	2003-060	
45 mm	app. 9 kJ = Net cl. B1	<ul style="list-style-type: none"> <li>● Green</li> <li>○ White</li> <li>● Blue</li> <li>● Black</li> <li>● Red</li> <li>● Hemp</li> </ul>	PS-no. 18100010	2003-045	

### every 2.5 m - standard sizes

*Description:* Knotless system-S safety net conforming to EN 1263-1 (rope-edged safety net) in approx. 5 mm high-tenacity polypropylene. Square mesh, edged all round with approx. 12 mm, 30-kN rope and thimbles every 2.50 m.

Energy absorption approx. 4.8 kJ. Net class A2. GS test certificate : PS-no. .18100013

Mesh size	Colours*	Size	Art.-No.	Price / each
100 mm	<ul style="list-style-type: none"> <li>● Green</li> <li>● Black</li> </ul>	5 × 10 m	20030-100	
100 mm	<ul style="list-style-type: none"> <li>● Green</li> <li>● Black</li> </ul>	6 × 10 m	20031-100	

**Art.-No. 2017** Additional charge for extra plastic thimble, incorporated into the rope edge.

**Art.-No. 2021** Additional charge for extra metal thimble, incorporated into the rope edge.

### Surcharge for small quantities:

Nets under 1 m<sup>2</sup>: upon request  
 Nets under 5 m<sup>2</sup> + 100% per net  
 Nets under 10 m<sup>2</sup> + 35% per net  
 Nets under 20 m<sup>2</sup> + 20% per net

*The surcharge is based on the size of a single net, and not on the total order.*

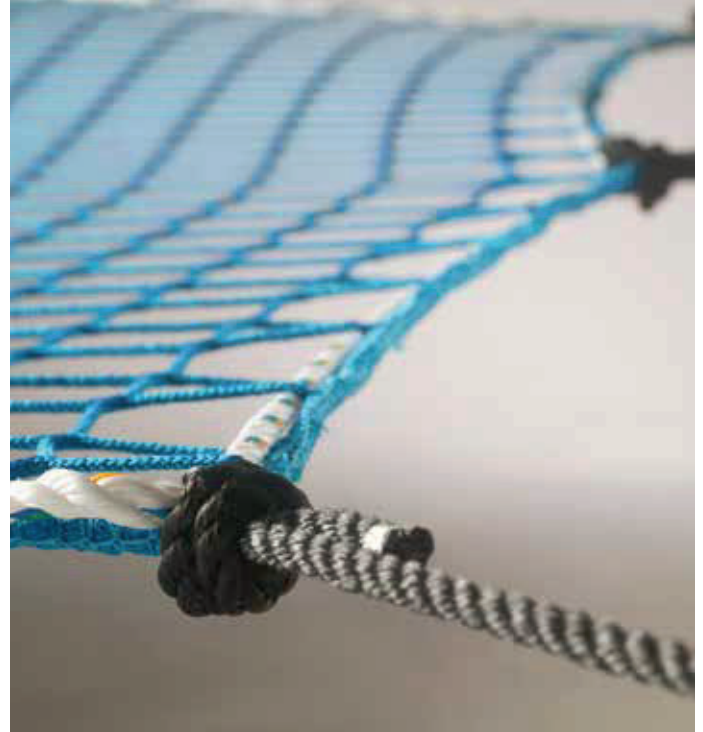

## Safety net with rope edging all round and suspension ropes

• with Suspension Ropes •

(spliced loop at one end) every 2.50 m

### Any size

*Description:* Knotless system-S safety net conforming to EN 1263-1 in approx. 5 mm high-tenacity polypropylene. Square mesh, edged all round with approx. 12 mm, 30-kN rope. Suspension ropes fastened to net every 2.50 m: type L in 12-mm PA (30 kN), 2.50 m long, white. With spliced loop at one end.

(no loop) every 2.50 m

### Standard sizes

*Description:* Knotless system-S safety net conforming to EN 1263-1 in approx. 5 mm high-tenacity polypropylene. Square mesh, edged all round with approx. 12 mm, 30-kN rope. Suspension ropes fastened to net every 2.50 m: type M in 12-mm PA (30 kN), 2.50 m long, black, no loop.

Mesh size	Energy-absorption	Colours	Art.-No.	Price /m <sup>2</sup>
100 mm	app. 4.8 kJ = Net cl. A2	<ul style="list-style-type: none"> <li>● Green</li> <li>○ White</li> <li>● Orange</li> <li>● Blue</li> <li>● Yellow</li> <li>● Black</li> <li>● Red</li> <li>● Hemp</li> </ul>	2103-100	
60 mm	app. 6.1 kJ = Net cl. A1	<ul style="list-style-type: none"> <li>● Green</li> <li>● Blue</li> <li>● Red</li> </ul>	2103-060	
45 mm	app. 9 kJ = Net cl. B1	<ul style="list-style-type: none"> <li>● Green</li> <li>○ White</li> <li>● Blue</li> <li>● Black</li> <li>● Red</li> <li>● Hemp</li> </ul>	2103-045	

Mesh size	Size	Colours	Art.-No.	Price / each
100 mm	5 × 10 m	<ul style="list-style-type: none"> <li>● Green</li> <li>● Black</li> </ul>	21030-100	
100 mm	6 × 10 m	<ul style="list-style-type: none"> <li>● Green</li> <li>● Black</li> </ul>	21031-100	

- = 01 = green
- = 015 = dark green
- = 02 = white
- = 03 = orange
- = 04 = blue
- = 05 = yellow
- = 06 = black
- = 07 = red
- = 08 = hemp

Example of product number 2103-100-07  
 Specification Mesh size Colour

### Surcharge for small quantities:

Nets under 1 m<sup>2</sup>: upon request  
 Nets under 5 m<sup>2</sup> + 100% per net  
 Nets under 10 m<sup>2</sup> + 35% per net  
 Nets under 20 m<sup>2</sup> + 20% per net

The surcharge is based on the size of a single net, and not on the total order.



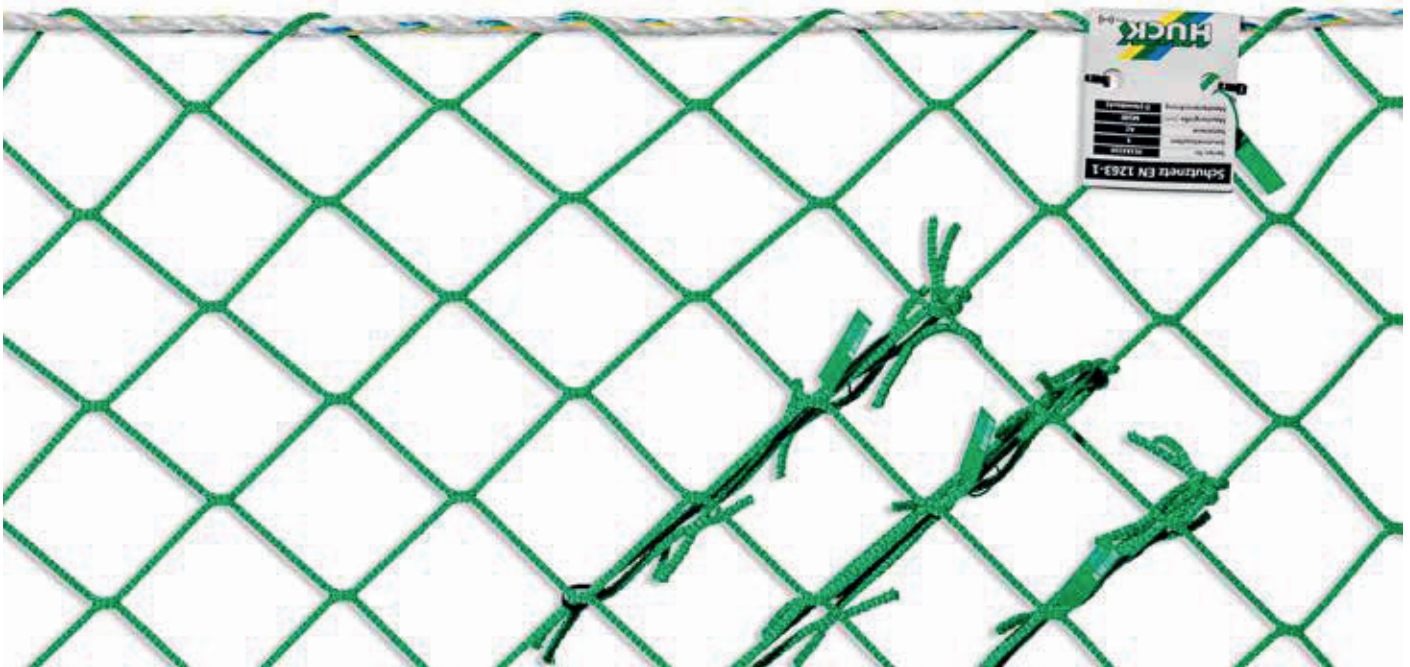

## Safety nets with rope edging all round

• Diamond Mesh •

### Any size

*Description:* Knotless system-S safety net conforming to EN 1263-1 (rope-edged safety net) in approx. 5 mm high-tenacity polypropylene. Diamond mesh, edged all round with approx. 12 mm, 30-kN rope.

### Standard sizes

*Description:* Knotless system-S safety net conforming to EN 1263-1 in approx. 4.75 mm high-tenacity polypropylene. Diamond mesh, edged all round with approx. 12 mm, 30-kN rope.

Energy absorption approx. 4.8 kJ. Net class A2. GS test certificate : PS-no. .18100009

Mesh size	Energy-absorption	Colours*	GS test certificate	Art.-No.	Price / m <sup>2</sup>
100 mm	app. 5 kJ = Net cl. A2	● Green	PS-no. 18100014	1803-100	
60 mm	app. 9 kJ = Net cl. B1	● Green	PS-no. 17100012	1803-060	

Mesh size	Size	Colours	Art.-No.	Price / each
100 mm	5 × 10 m	● Green	18040-100	
100 mm	6 × 10 m	● Green	18041-100	
100 mm	10 × 10 m	● Green	18042-100	
100 mm	7.50 × 15 m	● Green	18043-100	
100 mm	8 × 25.50 m	● Green	18044-100	
100 mm	12.50 × 20.50 m	● Green	18045-100	
100 mm	12.50 × 25.50 m	● Green	18046-100	

### Surcharge for small quantities:

Nets under 1 m<sup>2</sup>: upon request  
 Nets under 5 m<sup>2</sup> + 100% per net  
 Nets under 10 m<sup>2</sup> + 35% per net  
 Nets under 20 m<sup>2</sup> + 20% per net

*The surcharge is based on the size of a single net, and not on the total order.*

Please follow the instructions given on page 15 for tying a “clove hitch” so that you can put up an EN 1263-1 type S safety net with a suspension rope simply and safely!

As a standard solution for fall arrest nets that also need to protect people from falling objects, complete packages are available in standard sizes, in which the fall arrest net is already backed with an impermeable tarpaulin or an air-permeable fabric.



Art.-No. 22041



Art.-No. 23041



## Fall arrest nets with tarpaulins – complete packages

### Complete package

#### Fall arrest net with impermeable overlay panel

Knotless safety net conforming to EN 1263-1 in approx. 5 mm ht. green polypropylene. Mesh size 100 mm, edged with 30-kN rope.

Ready equipped with overlaid transparent tarpaulin panel, approx. 150 g/m<sup>2</sup>, edged with PP cord and aluminium eyelets every 100 cm, and already attached to safety net with hog rings or cable ties at approx. 1 m intervals.

### Complete package

#### Fall arrest net with air-permeable woven panel (dust-protection net)

Knotless safety net conforming to EN 1263-1 in approx. 5 mm ht. green polypropylene. Mesh size 100 mm, edged with 30-kN rope.

Ready equipped with overlaid HDPE woven panel (dust-protection net), approx. 100 g/m<sup>2</sup>, edged with eyelets every 5 cm, and already attached to safety net with hog rings or cable ties at approx. 1 m intervals.

Mesh size	Size	Colours	Art.-No.	Price / each
100 mm	6 × 10 m	● Green	22041	
100 mm	8 × 10 m	● Green	22042	
100 mm	10 × 12 m	● Green	22043	
100 mm	10 × 15 m	● Green	22044	

Mesh size	Size	Colours	Art.-No.	Price / each
100 mm	6 × 10 m	● Green	23041	
100 mm	8 × 10 m	● Green	23042	
100 mm	10 × 12 m	● Green	23043	
100 mm	10 × 15 m	● Green	23044	



## Netting suspension with ropes

When using single rope suspension, rope with a minimum breaking force of 30 kN must be used.

**No. 2011 Suspension rope EN 1263-1, (Type L)** made of PA 12 mm dia. For single rope suspension. One end with spliced in loop, the other end firmly sealed off, length 2.50 m, the minimum breaking force for the rope is 30 kN.



Most bridges were built in the 60s and 70s from reinforced concrete. Damage caused by increasing loads, environmental stresses and road salt can be secured with safety nets. This protection of the underneath is an economical interim solution until complete restoration is possible.

## Safety Nets with overlay panels (all sizes)

### HUCK safety nets with overlay panels provide safety and protection from falling concrete

Knotless system-S safety net conforming to EN 1263-1 (rope-edged safety net) in high-tenacity polypropylene. Square mesh, approx. 5 mm thick, edged all round with approx. 12 mm, 30-kN rope.

Also fitted with air permeable tarpaulins (Art. No. 720) or also fitted with air-impermeable tarpaulins (Art. No. 340)

Mesh size	Energy-absorption	Colours*	GS test certificate	Art.-No.	Price / m <sup>2</sup>
100 mm	app. 4.8 kJ = Net cl. A2	<ul style="list-style-type: none"> <li>● Green</li> <li>○ White</li> <li>● Orange</li> <li>● Blue</li> <li>● Black</li> <li>● Red</li> </ul>	PS-no. 18100013	1903-100	
60 mm	app. 6.1 kJ = Net cl. A1	<ul style="list-style-type: none"> <li>● Green</li> <li>● Blue</li> </ul>	PS-no. 18100012	1903-060	
45 mm	app. 9 kJ = Net cl. B1	<ul style="list-style-type: none"> <li>● Green</li> <li>○ White</li> <li>● Blue</li> <li>● Red</li> </ul>	PS-no. 18100010	1903-045	

\* for colour codes see page 8



### Netting suspension with ropes

When using single rope suspension, rope with a minimum breaking force of 30 kN must be used.

#### No. 2011

**Suspension rope EN 1263-1, (Type L),** made of PA 12 mm dia.

For single rope suspension. One end with spliced in loop, the other end firmly sealed off, length 2.50 m, the minimum breaking force for the rope is 30 kN.



#### No. 35000

The panels are attached to safety nets using cable ties, which are placed 1 m apart.

**No. 720** rotproof, air-permeable, UV-stabilised heavy duty knitted panels (approx. 200 g per m<sup>2</sup>). The panels are inclusive of eyelets at 50 cm intervals.

● Dunkelgrün **No. 340** Tarpaulin made of coated HDPE tape fabric, approx. 190 g per m<sup>2</sup>, seamed all round as well as eyelets 50 cm apart. Tear strength lengthwise and across:

approx. 850 N/5 cm. Temperature resistance: - 40° to + 80°.

● Natural

### Surcharge for small quantities:

Nets under 1 m<sup>2</sup>: upon request  
 Nets under 5 m<sup>2</sup> + 100% per net  
 Nets under 10 m<sup>2</sup> + 35% per net  
 Nets under 20 m<sup>2</sup> + 20% per net

*The surcharge is based on the size of a single net, and not on the total order.*

**Overlay panels for safety nets**

As well as providing personal protection, safety nets are often required to catch small falling objects. If this is the case, we suggest using an overlay panel or close-meshed overlay net in combination with our safety nets (pages 6 - 10).

**Impermeable overlay panels****• Airtight and waterproof overlay panels •****Standard sizes**

Transparent tarpaulin, approx. 150 g/m<sup>2</sup>, edged with PP cord and aluminium eyelets every 100 cm.

Size	Art.-No.	Price / each
6 × 10 m	35101-025	
8 × 12 m	35102-025	
10 × 12 m	35103-025	
10 × 15 m	35104-025	

**No. 35000**

The panels are attached to safety nets using cable ties, which are placed 1 m apart.

When using single rope suspension, rope with a minimum breaking force of 30 kN must be used.

**No. 2011 Suspension rope EN 1263-1, (Type L)**, made of PA 12 mm dia. For single rope suspension. One end with spliced in loop, the other end firmly sealed off, length 2.50 m, the minimum breaking force for the rope is 30 kN.



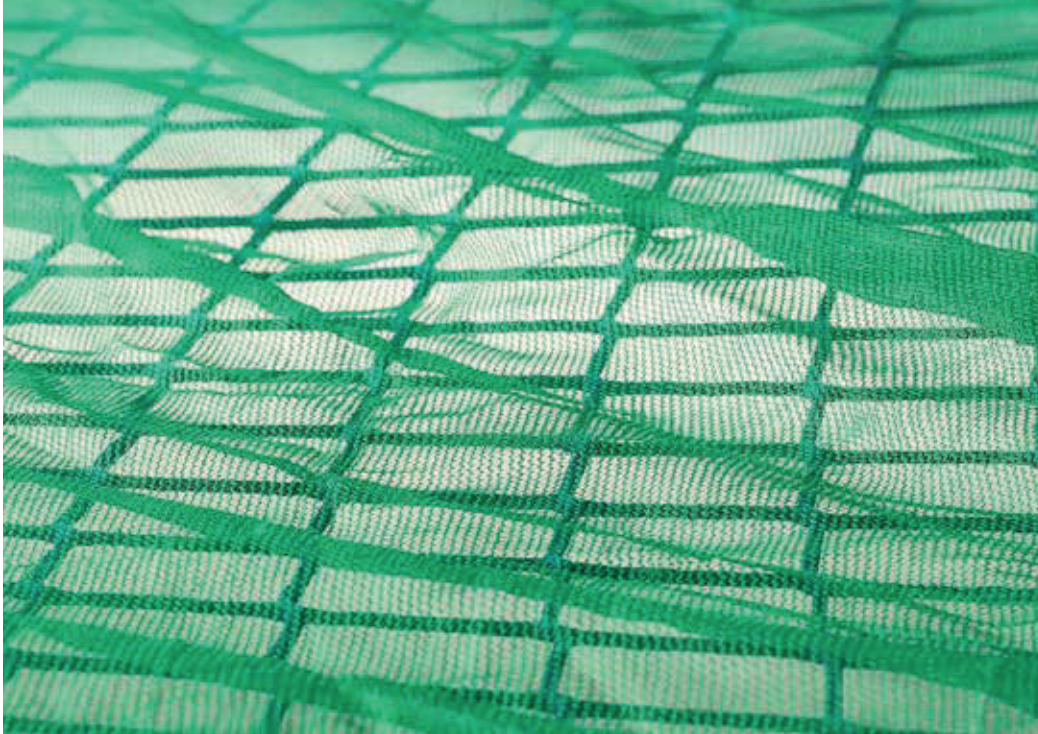

①

Air-permeability prevents the panel from ballooning. While air-permeable overlay panels are not as sturdy as overlay nets, they have a smaller mesh size.

Again, they do not have the same density as standard overlay panels, but their permeability ensures that they have a lower wind load.

## Air-permeable overlay panels ①

### Standard sizes

Woven double rib panels made of monofilament high-density polyethylene with polyester yarn along the top and bottom edges. Eyelets every 5 cm all round. 100 g/m<sup>2</sup>, colour green

Size	Art.-No.	Price / each
6 × 10 m	74201-01	
8 × 10 m	74202-01	
10 × 12 m	74203-01	
10 × 15 m	74204-01	

**Air-permeable overlay panels are used in combination with safety nets. They do not replace personal protection. Suitable safety nets can be found on pages 6 - 9.**

### Surcharge for small quantities:

Nets under 1 m<sup>2</sup>: upon request  
 Nets under 5 m<sup>2</sup> + 100% per net  
 Nets under 10 m<sup>2</sup> + 35% per net  
 Nets under 20 m<sup>2</sup> + 20% per net

*The surcharge is based on the size of a single net, and not on the total order.*

## Overlay nets ②

Instead of panels, close-meshed nets can also be used.

### No. 2007-020

Overlay net made of high-tenacity polypropylene, approx. 1.8 mm, mesh size approx. 20 mm, firmly attached to the safety net every 75 cm.

○ White ● Black

### No. 35000

The panels are attached to safety nets using cable ties, which are placed 1 m apart.

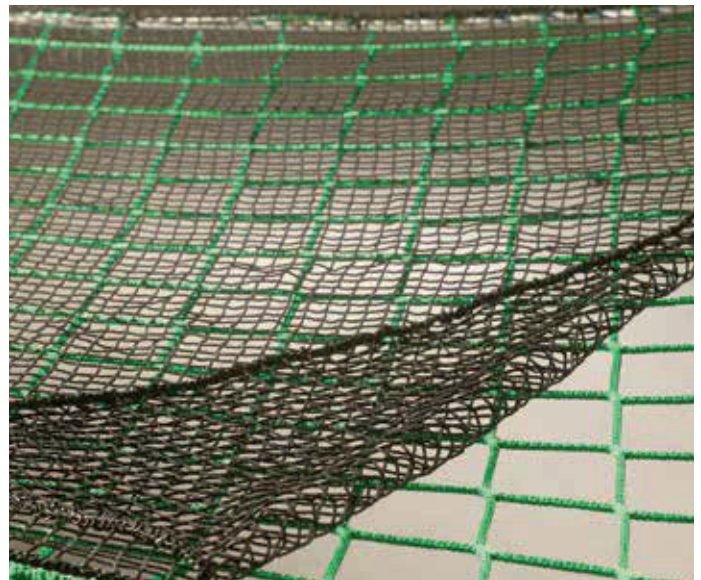

②

When installing nets it is important to comply with EN 1263-1 in conjunction with DGVU-Regel 101-011.

These regulations state that safety nets must be secured to load-bearing suspension points that are no more than 2.50 m.

Each suspension point must be designed for a characteristic load of at least 6 kN. Nets are suspended using ropes, snap hooks, straps or clips.



## Netting suspension with ropes

When using single rope suspension, rope with a minimum breaking force of 30 kN must be used.

**No. 2011 ,Suspension rope EN 1263-1, (Type L)**, made of PA 12 mm dia. For single rope suspension. One end with spliced in loop, the other end firmly sealed off, length 2.50 m, the minimum breaking force for the rope is 30 kN.

## Joining rope (Type 0)

made of polysteel, approx. 9 mm thick (15 kN), for connection of several safety nets to cover one large area.

**No. 21380 (Type 0)**  
supplied loose.

○ White

**No. 21380R (Type 0)**  
in coils of 220 m.

○ White

## Cross ropes

Cross ropes can be used to reduce the sag of the net.

**No. 2137 Cross rope (Type M)**, polysteel approx. 12mm dia, (30 kN). Threaded longitudinally and transversely through the mesh and fastened to the surround rope on both sides.

○ White

**No. 21370 Cross rope (Type M)**  
supplied loose

○ White

**No. 21370R Cross rope (Type M)**  
in cables of 220 m.

○ White



## Netting Suspension

Normally safety nets are secured with suspension ropes. According to EN 1263-1, suspension ropes can either have loops or not. The inner length of the loop is equal to at least 150 mm. Often these suspension ropes have a loop on one end while the other end is protected against untwisting (see Art.-No. 2011, page 14).

The loop end is secured to the net, and the net is then knotted onto the suspension point with the free end. The knot used is usually a „clove hitch” (see illustrations).

①



②



③



④



## Hanging Nets

**No. 2022** **"Grippa" Safety net hook**, for securing nets. Particularly suitable for securing them to the underside of I-beams when laying metal profiles.



Hanging the edge rope in the hook on the underside of the flange grip in a twisted position prevents unintentional detachment of the net.  
The two flange grips encircle the I-beam and are closed by pulling a strap with a snap lock.



**No. 2025** **Safety net suspension** (for wooden joist.)  
Steel bracket with screws 12 x 100 mm.

## Synthetic ropes made of polysteel, white with Huck-stripes

For the most varied fields of application in the industrial and construction sector we offer you synthetic ropes in cables of 2 standard lengths.

Cable length	Weight	Rope dia.	Min breaking strength	Art.-No.	Price/cable
220 m	50 g/m	9 mm	15 kN	21380R-02	
220 m	74 g/m	12 mm	30 kN	21370R-02	



Frequently netting suspension is achieved with suspension ropes. Further possibilities are provided for safety net suspension by safety snap hooks as well as by net safety hooks designed by us.

**No. 2020** **Net safety hook** in steel, loose.  
(See page 1.3).



**No. 2015** **Aluminium safety snap hooks**, D shaped, 114 x 12 mm to fasten safety nets, EN 362, breaking strength in longitudinal axis approx. 22 kN.



**No. 2016** **Fire brigade snap hooks**, to fasten side safety nets, breaking strength approx. 18 kN. Galvanised, size 120 x 11 mm, to C-DIN 5299. *Only suitable for attaching at short intervals, Maximum interval: 1 m!*



**No. 2024** **"Net Claw" hooks**, 40 mm, for the attachment of safety nets with a 30 mm flange.

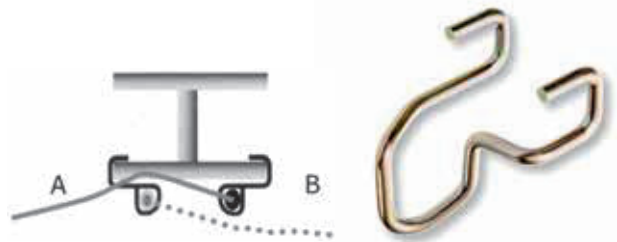

**No. 725 Storage sack** (Size: 60 x 100 cm).

Made from UV-stabilised woven polyethylene material. With pullcord. Suitable for one safety net (size: 6 x 10 m) or for two side safety nets (size: 2 x 10 m).







Because in the last few years very serious injuries have occurred time and time again specifically due to the lack of dome light safety systems, the demand from companies for a mobile safety option is growing for the protection of person for roof work. During maintenance work or clearance work in the winter in particular, the potential source of danger of dome lights is often under-estimated and unfortunately is often the result of more and more fatal work accidents.

## Dome light safety system

The roof fall protection system and roof safety are nowadays very important terms for any work or checks performed on buildings.

The following tests are available for the Huck dome light net:

- a) Fall protection safety following DIN EN 1263-1
- b) Stop device according to DIN EN 795:2012 Class B
- c) EC Prototype test certificate ZP/B114/17 with CE label (C€0158)

### No. 17410-100-01

Dome light net (from Article No.17041-100-01)

Fall protection safety following EN 1263-1,  
Size: 2 × 2 m

- Green

### No. 17411-100-01

Dome light net (from Article No.17041-100-01)

Fall protection safety following EN 1263-1,  
Size: 3 × 3 m

- Green

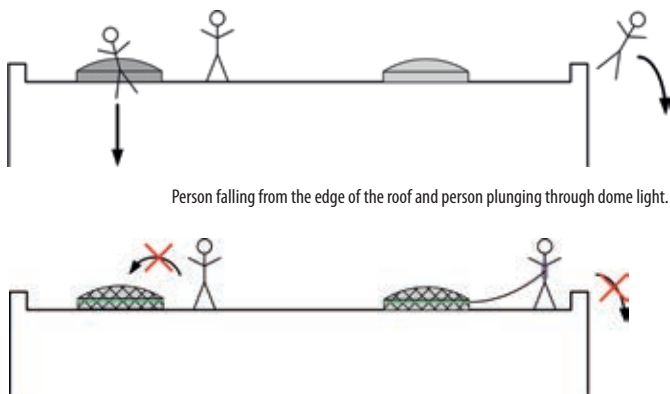

Person falling from the edge of the roof and person plunging through dome light.

As in image 1, but with net and PPE

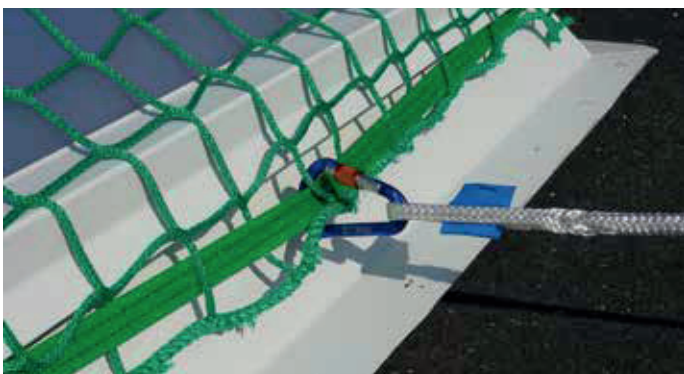

Attachment point for carabiner

### Components and net dimensions:

- (a) Net up to 3 × 3 m
- (b) Handles
- (c) Test mesh

### Stop device:

- (d) Webbing 8.50 m
- (e) Ratchet

### Material:

Netting: high tenacity polypropylene  
Ratchet: Steel, galvanised

Application: Fall protection and stop mechanism for **one person**.

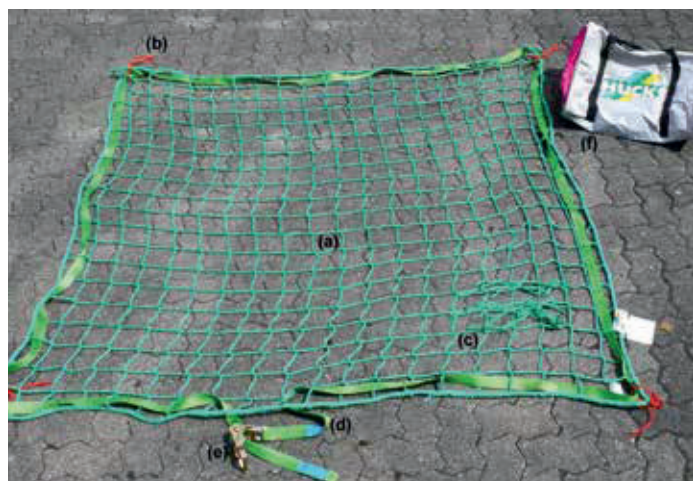

Safety nets ensure safety for everyone on construction sites and guarantee full freedom of movement for workers. This freedom is not provided by personal protection equipment safety lines.

For this reason, the use of safety nets to meet the legal requirements of fall protection is rapidly increasing.



## Fall Arrest Safety Equipment Training

We hire out standard net sizes for correct construction site fall protection according to the guidelines of the German Construction Trade Association.

### No. 10000

Hire price for 4 weeks up to 1000 m<sup>2</sup>

### No. 11000

Hire price for 4 weeks over 1000 m<sup>2</sup>

### No. 12000

Hire price per week from 5th week

### Ordering information

Prices are net (no discounts) ex-works. Return of nets is to take place carriage paid. The hire price does not include suspension ropes for assembly. Hire is always for a fixed period of 4 weeks. From the 5th week, calculation is made on a weekly basis. Each new week will be calculated as a full week. Further details are available in the terms & conditions which are sent with the quotation/order confirmation.

### With the first order, we reserve the right to take a deposit for the hired nets

When ordering, the expected hire period must be stated. Any extension must be communicated to us immediately.

### Net sizes

The following net sizes are available:

6.00 × 10.00 m	10.50 × 20.50 m
10.00 × 10.00 m	12.50 × 20.50 m
7.50 × 15.50 m	
12.50 × 15.50 m	

The total area of the hired nets is used for calculation. Overlapping of the nets must be taken into account, such that the area of nets exceeds the area to be secured by approximately 20%.

**No. 2011 Suspension rope EN 1263-1 (Type L)**, made of PA 12 mm dia., for single rope suspension. One end with spliced-in loop, the other firmly sealed. Length 2.50m. Minimum breaking strength 30kN.

**No. 21370 Cross rope (Type M)** to reduce sagging of the net, polysteel approx. 12 mm dia. (30kN) (supplied loose).

○ White

### No. 21370R Cross rope (Type M)

Polysteel approx. 12 mm dia. (30kN) in coils of 220 m.

○ White

### No. 21380R Cross rope (Type O)

Polysteel approx. 9 mm dia. (15kN) in coils of 220 m.

○ White

See also our safety net assembly guide on pages 20 and 21.

**We hire out only HUCK nets meeting DIN EN 1263-1 with a maximum mesh width of 100 mm.**





If nets are to be installed properly, installation must be undertaken by trained staff. If you do not have appropriately trained staff or the necessary specialist knowledge, we can install/dismantle your safety nets for you.

Take advantage of this offer and let our specialist team protect your building site properly.

## Safety Net Assembly

The HUCK company is a member of a working group within the specialist "safety nets" area of the BG-Bau trade association in the building trade. This working group has developed the DGVV Principle 301-004 "Training of net installers for the installations of safety and working platform nets".

From this a seminar for net installers was developed, which is offered by the specialised field of "safety nets" in the "personal protective equipment" technical committee. This resulted in a specific net installer seminar being held for the first time, based on the experiences of the building site situations faced and taking into account the current incidence of accidents. Something that is now a regular feature.

Alongside theoretical principles, value was placed on practical exercises in particular here.

### Order information

All our underslung safety nets – including or excluding erection – are always hired out for a set period of 4 weeks. Starting from the 5th week, the hire costs are calculated weekly. Any part of a week counts as a full week.

A lead time of 5 working days is deemed to have been agreed for the dismantling and reinstallation of safety nets. This does not include Saturdays, Sundays and public holidays. The lead time begins on the first working day after the contractor has confirmed availability/the order. Please also read our terms and conditions of sale.

We only hire out and erect HUCK nets conforming to EN 1263-1 with a mesh size of 10 cm.

**We can only draw up a binding quotation after receiving these plans or after having inspected the site. Please refer to the terms of the contract supplied with your quotation for further details.**

### Order help

We would ask you to submit a detailed enquiry as per the enquiry sheet on page 22.

Please ask us for a quotation while you are still at the planning stage!

Please also read our safety net assembly instructions on pages 20 and 21.



## Safety Net Installation Information



①

### Applicable standards and rules and regulations

Fall arrest safety nets must comply with the safety requirements of EN 1263-1. For the erection or assembly of fall arrest nets EN 1263-2 and DGUV 101-011 are applicable here.

**HUCK's fall arrest nets comply with EN 1263-1**

#### ① Use

Safety nets are used to protect people who fall. Typically, they are used for building work at great heights, e.g. the construction of indoor facilities (see photo 1) and overhead cables or as a safety feature on scaffolding. They allow workers to move around freely.

#### ② Labelling

Every safety net must be labelled clearly in accordance with EN 1263-1 (see photo 2). The label must include the following information:

- Date of manufacture and name of manufacturer
- Net class in accordance with EN 1263-1
- Precise item designation (item number)
- Minimum energy absorption capacity or minimum tensile load of test mesh in accordance with ISO 1806
- Number of the inspection authority that certified the net.



Front of Label ②



Back of Label ②

#### ③ Annual inspection

On every HUCK safety net, there are lead seals with the same identity number on the safety net label and test mesh (see photo 3). This ensures that the safety net and test mesh belong together. No more than 1 year after the date of manufacture, the first test mesh must be sent to an authorised tester (e.g. the manufacturer). This tester verifies whether the net still has the necessary strength/ energy absorption capacity and produces documentary evidence of the results.

#### No. 9700: Inspection cost per test mesh

④ If the test results are positive, you will receive a new test badge bearing the identity number, which you then attach to the relevant net (see photo 4). The net can then be used for another year. Please also refer to the section on "when to discard nets".

#### Installing and dismantling personal safety nets

Nets may only be installed by workers who have been trained to FASET standards. Protection must be provided for those undertaking installation (safety harness, platform lift).

#### Necessary bracing forces

Safety nets are to be attached to load-bearing structures. For measuring each suspension point a characteristic load P of at least 6 kN with an angle of  $\alpha=45^\circ$  must be adopted. For measuring building components three characteristic loads of 4 kN, 6 kN and 4 kN at unfavourable points must be considered. The suspension points must be within 2.50m of each other.



③



Test badge showing identity number and next inspection date. ④

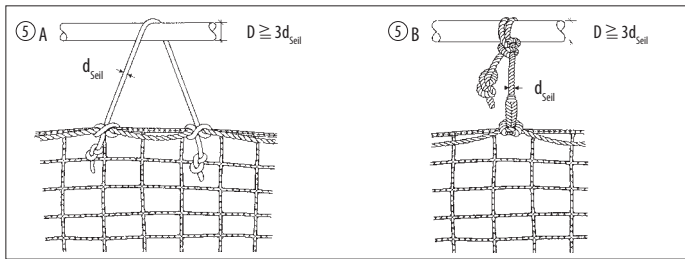

A): Double-strand suspension rope Z (breaking strength  $\geq 15$  kN)  
 B): Single-strand suspension rope L (breaking strength  $\geq 30$  kN)

5 Suspension

Nets are suspended with suspension ropes, snap hooks, net thimble straps or safety net thimble clips. For attachment types other than suspension ropes a safety factor of 2 must be used. For single rope suspension (Photo 5B) with suspension ropes the rope breaking force of the suspension rope must be at least 30 kN, for double suspension (Photo 5A) it is possible to suspend the net with 15-kN ropes. Snap hooks, which comply with DIN EN 362 "Personal fall arrest safety equipment - fastening elements", DIN EN 12 275 "Mountain climbing equipment; carabiners; safety requirements and test methods" or with DIN 5299 „snap hooks in semiround wire, round wire and forged" may be used. Further safety information can be found in the DGUV information sheet on safety nets.

Dimensions/minimum size

The values specified below assume a minimum size of 35 m<sup>2</sup>, whereby the length of the shortest side must be at least 5 m. If minimum sizes are not complied with, specific evidence is required (see DGUV 101-011, Annex 1).

6 Fall height/Minimum fall arrest width

Safety nets are preferably to be suspended underneath the work place being protected. If for technical reasons and structural conditions safety nets cannot be directly erected under the work place, the fall height H (vertical difference in height between the building edge and the area of impact in the safety net) should not exceed 6 m due to the physical properties of the safety net. On the outer edge up to 2 m (Hi1) the permissible fall height should not exceed 3 m.

7 Clearance underneath the safety net

Safety nets are to be suspended in such a way that during a fall persons cannot come into contact with the ground, hit fixed or moving objects and injure other persons in traffic routes. Deformation is related to the shortest side of the net and the fall height (see table 7 and photo 7). In addition to deformation a safety distance  $S > 0$  must be maintained for traffic routes etc. With suitable certification from the manufacturer and a fall height of up to 2 m nets may be used with a clearance of 3 - 5 m under the edge from which a fall could take place. Installations by us are carried out by qualified skilled staff.

Connecting safety nets.

When safety nets are connected then joining rope is used in such a way, that the space between the join is not more than 100 mm and the safety nets cannot move more than 100 mm away from each other. It is also possible to connect safety nets by overlapping them. But then the overlap must be at least 2 m.

Replacement state of wear

Nets should not continue to be used in the following circumstances:

- Nets, through which a person has already fallen
- Nets, which can no longer meet minimum breaking force (refer to section on "annual inspections" too)
- Nets, which are defective (= Nets with considerable wear and tear, defective mesh, damage to rope edge or clips)

Storage/safety precautions

Store in a dry place, never store close to a heat source, avoid contact with aggressive substances such as acids and alkalis etc., do not expose to direct UV radiation. Nets and ropes must not be dragged over sharp edges. Objects that have fallen into the net must be removed immediately, since persons could become injured by these upon impact and the load-bearing capacity of the net become impaired.

Repair/defects

Damaged nets must only be repaired by suitably qualified staff at the manufacturer's plant. If defects are identified, safety nets may only continue to be used at the discretion of an expert or must be repaired properly. When using nets under extreme temperatures of between  $< -20^{\circ}\text{C}$  or  $> +50^{\circ}\text{C}$ , please consult the manufacturer.

HUCK personal safety nets conform to DIN EN 1263-1.

Height of fall h (m)	1 m	2 m	3 m	4 m	5 m	6 m
Deformation $f_{\text{max}}$ (m) if l = 5 m	2.65	2.85	2.95	3.00	3.05	3.10
Deformation $f_{\text{max}}$ (m) if l = 9 m	3.35	3.55	3.75	3.85	3.95	4.00
Deformation $f_{\text{max}}$ (m) if l = 12 m	4.20	4.40	4.55	4.75	4.90	5.00

l = width of safety net (shortest side)

The width of the net is directly related to the height of the fall:

Height of fall $H_a$ :	$< 1.0$	$< 3.0$	$< 6.0$	metres
Minimum net width b:	$> 2.0$	$> 2.5$	$> 3.0$	metres

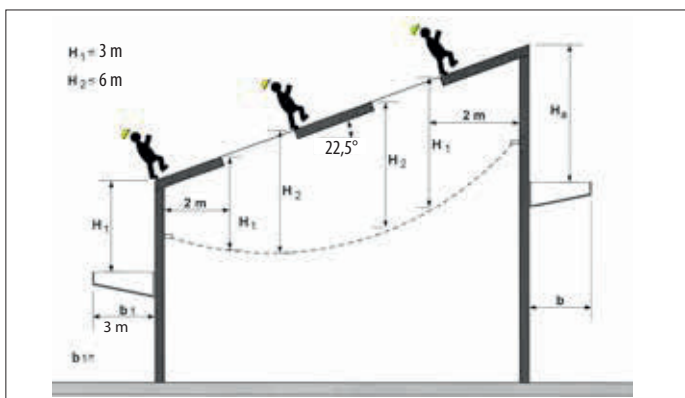

Classification flat roof from pitched roof in accordance with European standard now 22.5° 6

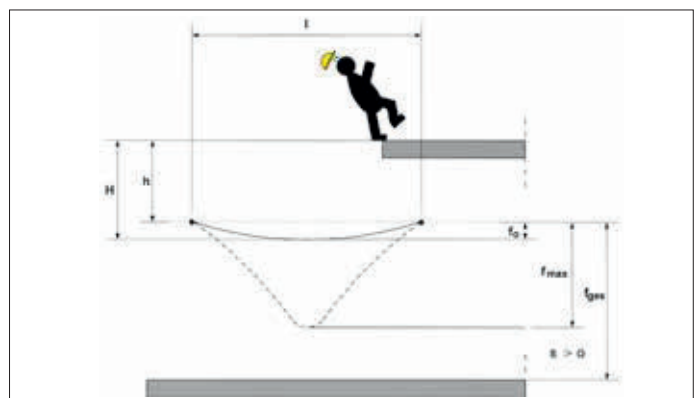

7

# HUCK Fax Request Form

The quickest way to obtain a detailed quote

Customer's Name: \_\_\_\_\_

Route description (with postcode, motorway exit, etc.)

Street: \_\_\_\_\_

Site location with postcode: \_\_\_\_\_

Tel. No.: \_\_\_\_\_ Fax No.: \_\_\_\_\_

E-mail: \_\_\_\_\_

1. Length of incline (A): \_\_\_\_\_

2. Height up to the roof projection (B): \_\_\_\_\_

3. Height up to ridge (C): \_\_\_\_\_

4. Width of the building (D): \_\_\_\_\_

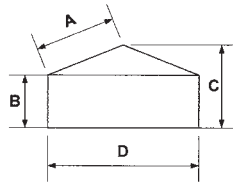

5. Special features of the building

- Canopies (Length × Width)
- Without columns
- With columns (for position of the columns see drawing)
- False ceilings or other built-in units
- Party walls (compartment wall)
- Sandwich (locking) plates or trapezoidal sheet
- Drawing, floor plan and sectional view enclosed

6. Please place a cross against type of roof

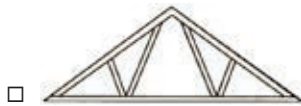

7. Total length (H): \_\_\_\_\_

8. Number of rafters: \_\_\_\_\_

9. Distance between rafters (girders) (F): \_\_\_\_\_

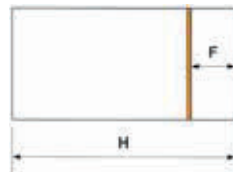

10. Support type:

- Wooden rafters
- Steel rafters
- Concrete girders

11. Type of construction work:

- New construction
- Renovation

12. Nature of the soil/ground: \_\_\_\_\_

13. Crane trackway existing:

- Yes
- No

14. Size of entrance: \_\_\_\_\_

Height × Width: \_\_\_\_\_

15. Elevator platform possible (means can handle traffic up to 7.5 t)

- Yes
- No

16. Start of net assembly: \_\_\_\_\_

17. Planned end of disassembly: \_\_\_\_\_

18. Please give any other relevant details on a separate sheet.

Notes:

\_\_\_\_\_

\_\_\_\_\_

\_\_\_\_\_

\_\_\_\_\_

\_\_\_\_\_



The use of EN 1263-1 safety nets is based on a minimum net size of 35 m<sup>2</sup>, in practice however there are many areas where this becomes difficult to achieve.

When BGR 179 was revised for the new DGUV-Regulation 101-011 Safety Net Information sheet this was taken into account and a corresponding supplement specifically for small safety nets was revised.

## Small Nets

This means that EN 1263-1 safety nets can be used below the minimum size requirements as long as the conditions for use have been redefined.

Special provisions for small safety nets with System S:  
DGUV-Regulation 101-011 Annex 1 and 2

- If the installation width is less than 5 m, a fall height of a maximum of 1.50 m must be observed. The mesh size must not exceed 100 mm.
- If the installation width is less than 3 m, a fall height of a maximum of 1.00 m must be observed. The mesh size must not exceed 100 mm.
- If the installation width is less than 2 m, the mesh size must not be larger than 60 mm and the fall height a maximum 0.50 m.
- The smallest area for small safety nets of System S must be at least 2 m<sup>2</sup>. For rectangular safety nets the length of the shortest side (net width) must be at least 1.0 m. The net width must exceed the gap of the overlying suspension-points by at least 0.10 m



The relevant tests for this were performed in the BIA in St. Augustin.



Net width	max. gap of fall height	gap of suspension points
1.00 m – < 2.00 m	0.50 m	< 1.00 m
2.00 m – < 3.00 m	1.00 m	< 1.50 m
3.00 m – < 5.00 m	1.50 m	< 2.00 m

Work-platform nets are used in areas that are inaccessible with scaffolding. In accordance with regulations, these nets are used as work places, and specific conditions must be observed around the edges. Information about this can be found in BG Bau's **DGUV-201-010**.



## Nets as work platforms

### Here are a few key facts:

Work-platform nets need to fulfil the following criteria:

- Net must conform to EN 1263-1, net-class B1, with max. mesh size of 45 mm and 60 mm.
- The nets must be installed no more than 1.50 m below the underside of the construction to be erected.
- The inclination of the installed net must be no greater than 20°.
- The nets must be secured with bands (as per DIN EN 12195-2) or ropes (30-kN-minimum breaking strength).
- The distance between two suspension points must be 50 cm maximum.
- Bracing straps must be threaded through the surface of the net – every ten meshes, for ten meshes – as cross braces.
- Grid size of the cross-brace straps must be max. 2 m × 2 m, at a 2 m distance from the net edge.

- The cross-brace straps are pre-tensioned by hand, making allowance for horizontal loads of at least 2.2 kN per suspension point.
- Maximum sag must be no more than 50 cm at the lowest point under the load of a person, or no more than 30 cm after re-tensioning on the second day.

### Further information can be found in Bau BG's DGUV-201-010 (Instructions manual for handling work platform nets).

The width of the net is directly related to the height of the fall:

Height of fall $H_f$ :	< 1.0	< 3.0	< 6.0	metres
Minimum net width b:	> 2.0	> 2.5	> 3.0	metres



Test: the 100-kg iron ball was dropped onto the net from a height of 3 m.

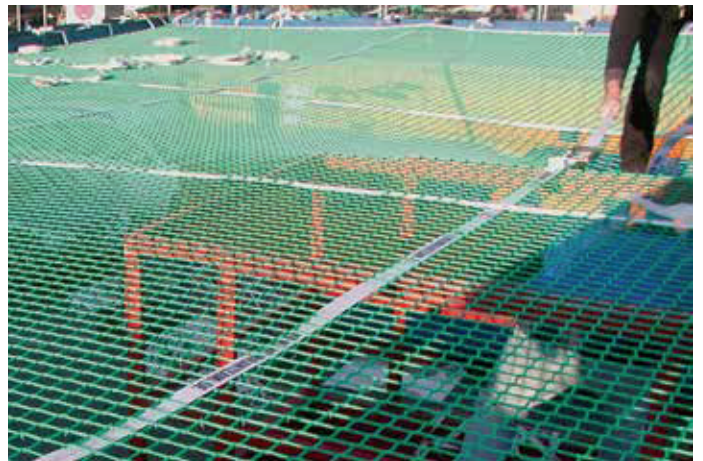

The nets are braced with straps along their length and breadth in a 2 × 2 m grid





## Nets as work platforms

*Description:* Knotless safety net, approx. 5 mm high-tenacity polypropylene, mesh size, approx. 45 mm, edged all round with approx. 12 mm, 30-kN rope. Energy absorption approx. 9 kJ.

### No. 5511-035

Buckle strap, 2-part, with heavy ratchet, SWL 1500 daN (kp)/3000 daN (kp), Standard length: 2 m = 0.50 m short end + 1.50 m loose end

### No. 5513-035

Buckle strap, 1-part, with heavy ratchet, SWL 3000 daN (kp), Standard length: 2 m = 1-part/loop

Mesh size	Energy absorption	Colours	GS certificate	Art.-No.	Price / m <sup>2</sup>
45 mm	app. 9 kJ = Net cl. B1	<ul style="list-style-type: none"> <li>● Green</li> <li>● Blue</li> </ul>	PS-no. 18100010	1903-045	

**other straps available on request**

### Surcharge for small quantities:

- Nets under 1 m<sup>2</sup>: upon request
- Nets under 5 m<sup>2</sup> + 100% per net
- Nets under 10 m<sup>2</sup> + 35% per net
- Nets under 20 m<sup>2</sup> + 20% per net

*The surcharge is based on the size of a single net, and not on the total order.*

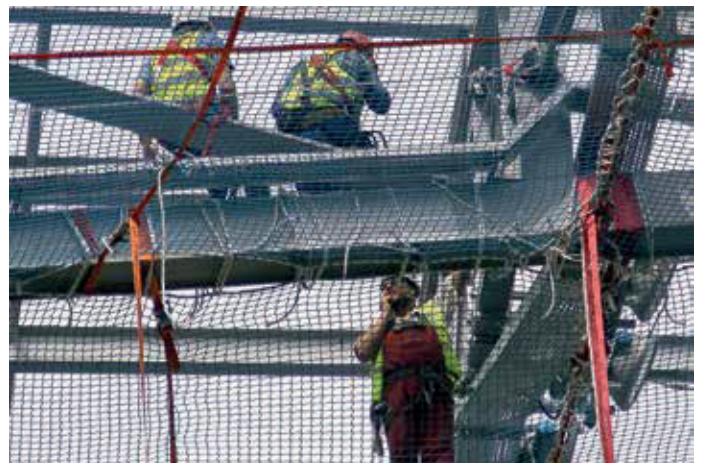

A personal safety rope is also required for the application illustrated above.



Brick guardrail net, mesh size 100 mm.

## Brick Guardrail Nets with Isilink Clips In Standard Sizes

### Guardrail nets complete with Isilink clips sewn on

Usage: For Guardrail nets and nets in roof safety scaffolding EN 1263-1 as well as for assembly EN 1263-2 and DGUV-I 201-023 are authoritative. They are clearly presented in the assembly and user instructions. These nets are classed as Safety Net System U (Safety Net in load bearing construction for vertical use). The mid-rail is not necessary when nets are used.

The mesh may be a maximum of 100 mm. The nets are equipped with an integral surround rope. We recommend assembly of side safety nets with our Isilink Clips, which are already sewn onto our side safety nets at 75 cm intervals, to comply with Bau-BG requirements.

### Standard sizes

Knotless guardrail nets conform to EN 1263-1, safety net system U. Made of ht polypropylene, approx. 5 mm thick, with integral surround rope and Isilink clips sewn on approx. 75 cm apart. Approved by Bau-BG, with Euro Test Certificate number:

Mesh size 45 mm: ET PS 18100026

Mesh size 60 mm: ET PS 18100027

Mesh size 100 mm: ET PS 18100028.

### Size 1: 1.5 m x 5 m, number Isilink Clips: 18

Meshsize	Colours	Art.-No.	Price / each
app. 45 mm	● green ● blue ● red	3005-045	
app. 60 mm	● green ● blue	3005-060	
app. 100 mm	● green ● blue ● red	3005-100	

● = 01 = green      ● = 04 = blue      ● = 07 = red

Example Article No.: 3005-100-07

Specification Mesh size Colour

### Size 2: 2 m x 5 m, number Isilink Clips: 20

Meshsize	Colours	Art.-No.	Price / each
app. 45 mm	● green ● blue ● red	3006-045	
app. 60 mm	● green ● blue	3006-060	
app. 100 mm	● green ● blue ● red	3006-100	

### Size 3: 1.5 m x 10 m, number Isilink Clips: 32

Meshsize	Colours	Art.-No.	Price / each
app. 45 mm	● green ● blue ● red	3007-045	
app. 60 mm	● green ● blue	3007-060	
app. 100 mm	● green ● blue ● red	3007-100	

### Size 4: 2 m x 10 m, number Isilink Clips: 34

Meshsize	Colours	Art.-No.	Price / each
app. 45 mm	● green ● blue ● red	3008-045	
app. 60 mm	● green ● blue	3008-060	
app. 100 mm	● green ● blue ● red	3008-100	



## The Isilink Clip

The further-improved Isilink Clip.  
For the fast and simple attachment of guardrail nets.  
Isilink is a registered EU trade mark.

### No. 3015

**Isilink Clip** sewn on to the net at intervals of 75 cm maximum.  
Length: approx. 60 cm

- Black

### No. 3016

**Isilink Clip** loose, as spare part.  
Length: approx. 60 cm

- Black

① – ③ An extremely easy way to secure guardrail nets to scaffolding tubes and one that is approved by the employers' liability insurance associations in the construction industry. Simply place the long end around the scaffolding tube (**photo 1**) and the hole in the Isilink cord around the clip like a buttonhole (**photos 2 and 3**). It can even be done when wearing work gloves and works in wet, cold and dirty conditions.

**Approved by Bau-BG, with Euro Test Certificate number: (see Page 24).**

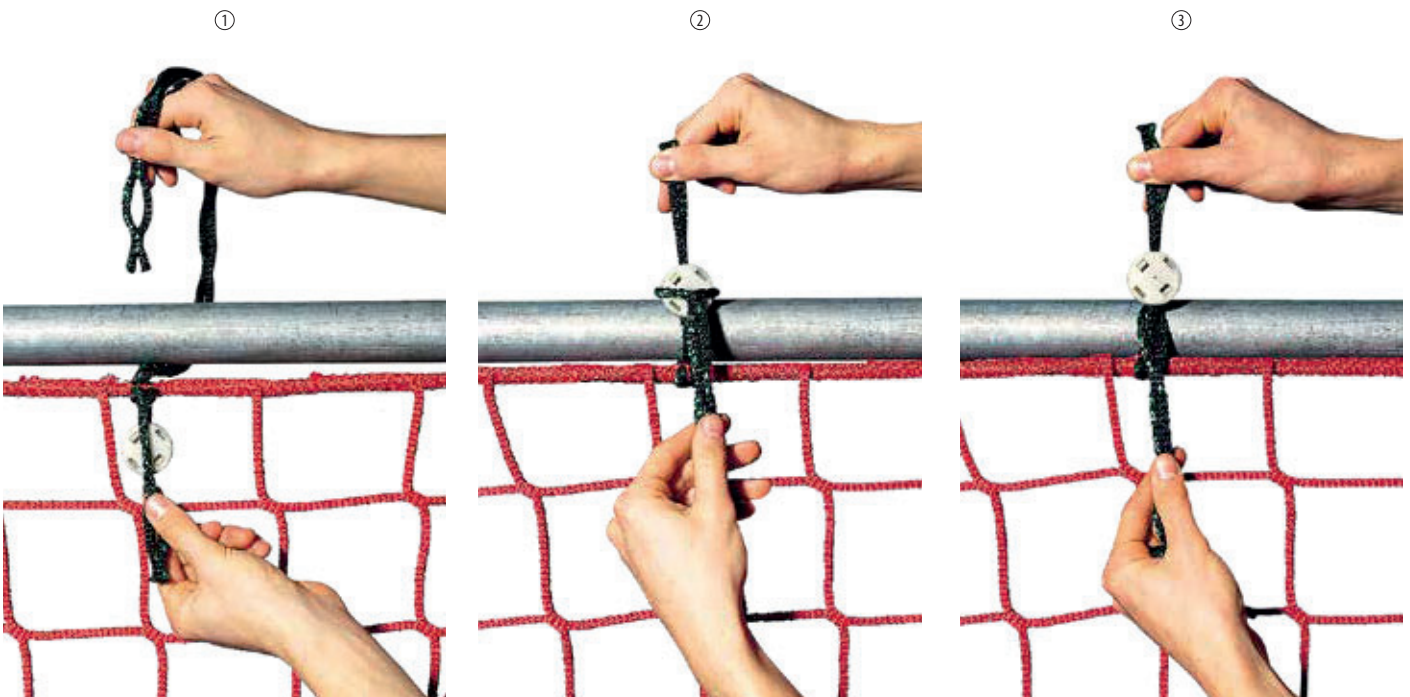



Article-no. 3001-100-07

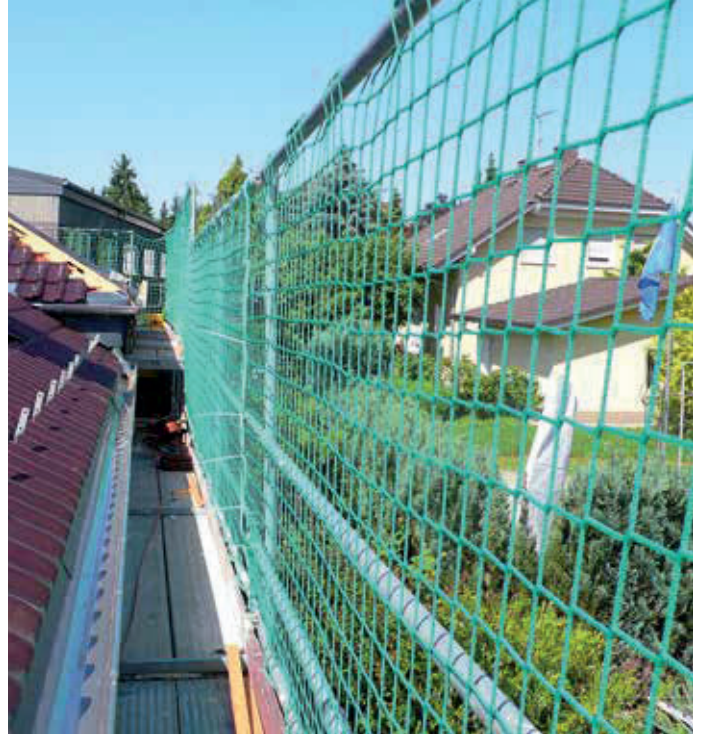

The guardrail is secured to the load-bearing construction mesh.

## Standard Sizes (without Isilink Clips or buckled straps)

Pursuant to BG modules/information B 156 and DGVU-1201-023 guardrail nets can be attached to the supporting structure in the standard design mesh for mesh. The frame tube can be simply pulled through the mesh.

In the standard design described, our nets have been certified by the Testing and Certification body of BG-PRÜFZERT by the Technical Committee for Construction, which is part of the German Federation of Industrial Trade Associations under Euro Test certificate number.

### Standard sizes (without Isilink Clips or straps)

Knotless guardrail nets conform to EN 1263-1, safety net system U. Made of high tenacity polypropylene, approx. 5 mm thick, with integral surround rope.

Approved by Bau-BG, with Euro Test Certificate number:

Mesh size 45 mm: ET PS 18100020

Mesh size 60 mm: ET PS 18100021

Mesh size 100 mm: ET PS 18100022.

### Size 1: 1.5 m x 5m

Meshsize	Colours	Art.-No.	Price / each
app. 45 mm	● green ● blue ● red	3001-045	
app. 60 mm	● green ● blue	3001-060	
app. 100 mm	● green ● blue ● red	3001-100	

● = 01 = green      ● = 04 = blue      ● = 07 = red

Example Article No.: 3001-100-07  
 Specification    Mesh size    Colour

### Size 2: 2 m x 5m

Meshsize	Colours	Art.-No.	Price / each
app. 45 mm	● green ● blue ● red	3002-045	
app. 60 mm	● green ● blue	3002-060	
app. 100 mm	● green ● blue ● red	3002-100	

### Size 3: 1.5 m x 10 m

Meshsize	Colours	Art.-No.	Price / each
app. 45 mm	● green ● blue ● red	3003-045	
app. 60 mm	● green ● blue	3003-060	
app. 100 mm	● green ● blue ● red	3003-100	

### Size 4: 2 m x 10m

Meshsize	Colours	Art.-No.	Price / each
app. 45 mm	● green ● blue ● red	3004-045	
app. 60 mm	● green ● blue	3004-060	
app. 100 mm	● green ● blue ● red	3004-100	

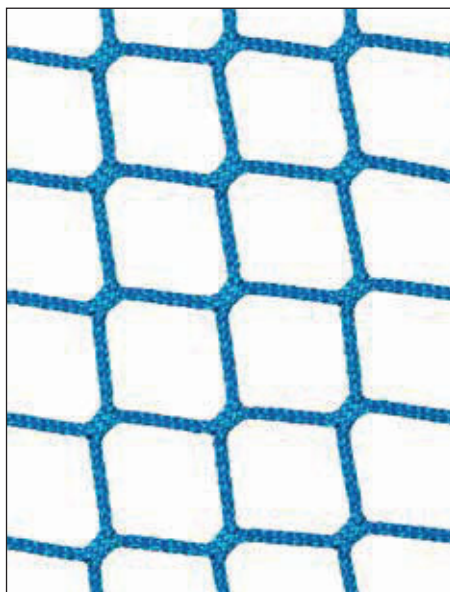

No. 3000-045-04

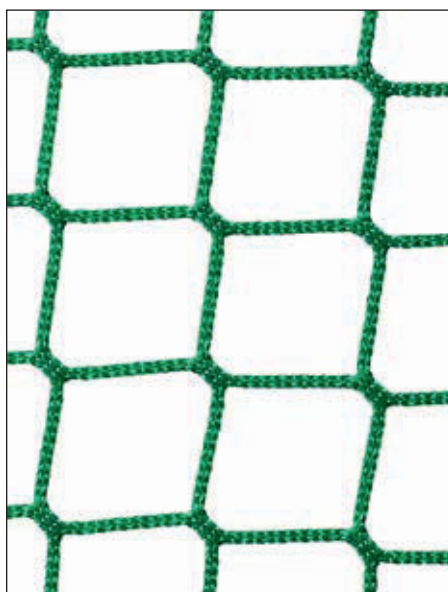

No. 3000-060-01

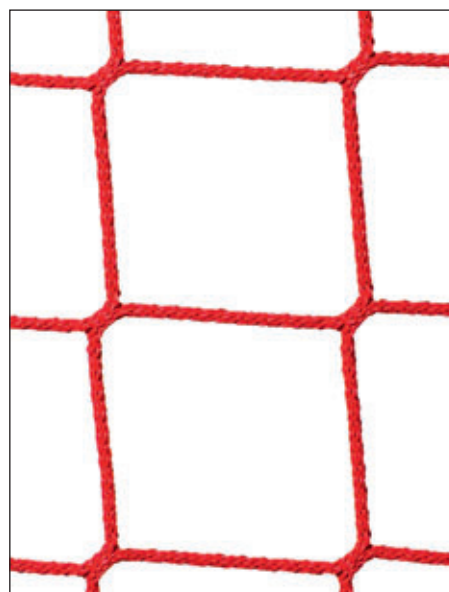

No. 3000-100-07

## Brick guardrail nets in All Sizes (without Isilink clips or buckled straps)

### In any size (without Isilink clips or buckled straps)

Knotless system-U guardrail net conforming to EN 1263-1. In approx. 5 mm high-tenacity polypropylene, edged all round with threaded-on edging rope.

Approved by Bau-BG, with Euro Test Certificate number:

Mesh size 45 mm: ET PS 18100020

Mesh size 60 mm: ET PS 18100021

Mesh size 100 mm: ET PS 18100022.

Meshsize	Energy absorption	Colours*	Art.-No.	Price / m <sup>2</sup>
app. 45 mm	app. 9 kJ = Net cl. B1	<ul style="list-style-type: none"> <li>● Green</li> <li>○ White</li> <li>● Blue</li> <li>● Black</li> <li>● Red</li> <li>● Hemp</li> </ul>	3000-045	
app. 60 mm	app. 6.1 kJ = Net cl. A1	<ul style="list-style-type: none"> <li>● Green</li> <li>● Blue</li> </ul>	3000-060	
app. 100 mm	app. 4.4 kJ = Net cl. A2	<ul style="list-style-type: none"> <li>● Green</li> <li>○ White</li> <li>● Orange</li> <li>● Blue</li> <li>● Yellow</li> <li>● Black</li> <li>● Red</li> </ul>	3000-100	

\* for colour codes see page 35

All information on energy intake relates to 3 × 3 m test net!

### Surcharge for small quantities:

Nets under 1 m<sup>2</sup>: upon request

Nets under 5 m<sup>2</sup> + 100% per net

Nets under 10 m<sup>2</sup> + 35% per net

Nets under 20 m<sup>2</sup> + 20% per net

The surcharge is based on the size of a single net, and not on the total order.

### Spare parts

#### No. 3011 Strap

with self locking buckle, 55 cm long – supplied loose and not fixed onto net.

● Green ● Blue ● Red

#### No. 3017 Strap

with self locking buckle, 1 m long – supplied loose and not fixed onto net.

● Green ● Blue ● Red

### Tensile strength of article No. 3011:

Breaking load when used as restraint according to EN 12 195-2: 5000 N



No. 3011



No. 3016

#### No. 21320

Nylon rope, approx. 8 mm dia., loose

○ White

#### No. 3016 Isilink-Clip,

loose as spare part. Length approx. 60 cm.

● Black



## Brick Guardrail Nets In Standard Sizes With Buckled Straps

Guardrail nets complete with buckled straps sewn on

### Standard sizes

Knotless guardrail nets conform to EN 1263-1, safety net system U. Made of ht polypropylene, approx. 5 mm thick, with integral surround rope and buckled straps sewn on approx. 75 cm apart, with Euro Test Certificate Number:

Mesh size 45 mm: ET PS 18100023

Mesh size 60 mm: ET PS 18100024

Mesh size 100 mm: ET PS 18100025



### Size 1: 2 m x 5 m, number buckled straps: 20

Meshsize	Colours	Art.-No.	Price / each
app. 45 mm	<ul style="list-style-type: none"> <li>● green</li> <li>● blue</li> <li>● red</li> </ul>	3006-045GSV	
app. 60 mm	<ul style="list-style-type: none"> <li>● green</li> <li>● blue</li> </ul>	3006-060GSV	
app. 100 mm	<ul style="list-style-type: none"> <li>● green</li> <li>● blue</li> <li>● red</li> </ul>	3006-100GSV	

### Spare parts

#### No. 3011 Strap

with self locking buckle, 55 cm long – supplied loose and **not** fixed onto net.

● green ● blue ● red

#### Nr. 3010 Strap

fixed onto net on approx. 75 cm apart . Length: approx. 55 cm

● green ● blue ● red

### Size 2: 2 m x 10 m, number buckled straps: 34

Meshsize	Colours	Art.-No.	Price / each
app. 45 mm	<ul style="list-style-type: none"> <li>● green</li> <li>● blue</li> <li>● red</li> </ul>	3008-045GSV	
app. 60 mm	<ul style="list-style-type: none"> <li>● green</li> <li>● blue</li> </ul>	3008-060GSV	
app. 100 mm	<ul style="list-style-type: none"> <li>● green</li> <li>● blue</li> <li>● red</li> </ul>	3008-100GSV	



The advantages of these ready assembled units are:

- Fall prevention is already built into the scaffolding
- No railings and mid bars necessary
- Assembly time is reduced considerably
- Savings are made on transport and storage costs



## Ready Made Net Protection Walls

Net protection walls: consisting of safety net EN 1263-1 system U, 5 mm high tenacity polypropylene, 60 mm mesh, attached to scaffolding tube with additional lacing rope, approx. 8mm, Euro Test Certificate Number: ET PS 18100021

Scaffolding width	Size of net protection wall	Colours*	Art.-No.	Price / each
2.50 m	1.50 × 2.50 m	● green ● blue	3033-060	
3.00 m	1.50 × 3.00 m	● green ● blue	3034-060	
2.50 m	2.00 × 2.50 m	● green ● blue	3035-060	
3.00 m	2.00 × 3.00 m	● green ● blue	3036-060	

**Spare nets** for net protection walls: consisting of safety net EN 1263-1 system U, 5 mm high tenacity polypropylene, 60 mm mesh with additional lacing rope of approx. 8 mm dia.

Scaffolding width	Size of net protection wall	Colours*	Art.-No.	Price / each
2.50 m	1.50 × 2.80 m	● green ● blue	3026-060	
3.00 m	2.00 × 2.80 m	● green ● blue	3027-060	
2.50 m	1.50 × 3.30 m	● green ● blue	3029-060	
3.00 m	2.00 × 3.30 m	● green ● blue	3030-060	

\* for colour codes see page 28

### No. 3031

**Spare aluminium scaffold tube**, 40 mm dia., with 40 cm long insertion end, **pipng length 2.50 m**, for No. 3033-060/3035-060.

### No. 3032

**Spare aluminium scaffold tube**, 40 mm dia., with 40 cm long insertion end, **pipng length 3.00 m**, for No. 3034-060/3036-60.

## Guardrail nets ending in close-mesh, air permeable panels

So that even small parts cannot fall through the lower part of the net, we offer side protection nets with 200-g fabric attached to the bottom.

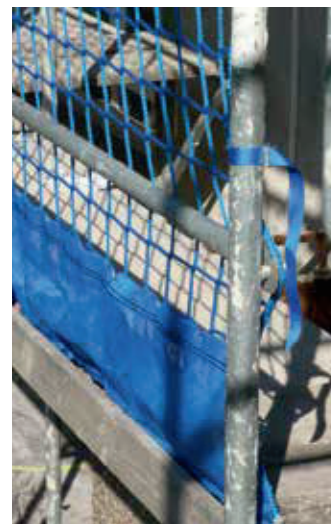

### No. 3208-100

Guardrail net in approx. 5 mm high-tenacity polypropylene. Mesh size approx. 100 mm. With integral rope edging all round, **and snap-buckle belt ties approx. every 75 cm**. Additionally, in the bottom 30 cm, with approx. 200g/m<sup>2</sup> PE fabric air-permeable secured to net.

Size: 2 × 10 m

● green ● blue

### No. 3204-100

Guardrail net in approx. 5 mm high-tenacity polypropylene. Mesh size approx. 100 mm. With integral rope edging all round. Additionally, in the bottom 30 cm, with approx. 200g/m<sup>2</sup> PE fabric air-permeable secured to net.

Size: 2 × 10 m

● green ● blue



## Roof Edge Protection

Typically laying the trapezoidal sheet metal alongside the fall arrest inside causes a problem with the roof edging protection on the outside. Basically there must be fall protection from a fall protection height of 3 m. According to DGUV-I 201-023 (Assembly of profile boards and cellular concrete panels) there must also be fall protection in the form of a guardrail or edge protection for ceilings and roofs with an incline of  $\leq 22.5^\circ$ .

For this we also offer our roof side protection in conjunction with fall arrest nets EN 1263-1, System S as a reasonably priced solution (DGUV Test-test certificate PS 1810001).

Our roof edge protection brackets (see image Page 33) can be attached to concrete supports for the assembly of edge safety nets etc. Thus still ensuring that the edge area is still protected after the trapezoidal metal sheet is laid for subsequent roof work. The consoles must first be dismantled for the subsequent outer cladding work.

**Please send us your enquiry in detail.**

A detailed description of our safety nets can be found on Pages 5 – 9.



### Building industry information on the security of brick guardrails, side protection, etc.

① The outward inclination of the side protection stanchion must be  $0^\circ$  (vertical). In departure from this, the inclination may be up to  $45^\circ$  from the vertical for constructional reasons (see fig. 1).

① + ② The length of the side protection stanchions shall be selected such that the distance of the upper surround rope radially to the edge of the roof

- in the area of the side protection stanchion is  $\geq 2.00$  m and
- in the middle of the intermediate space is  $\geq 1.50$  m. (see fig. 1 and 2).

The maximum spacing allowed between the brackets when using textile surroundropes is 10 m.

There must be no gaps of over 10 cm in the lower zone between the fall-off edge and the netting.

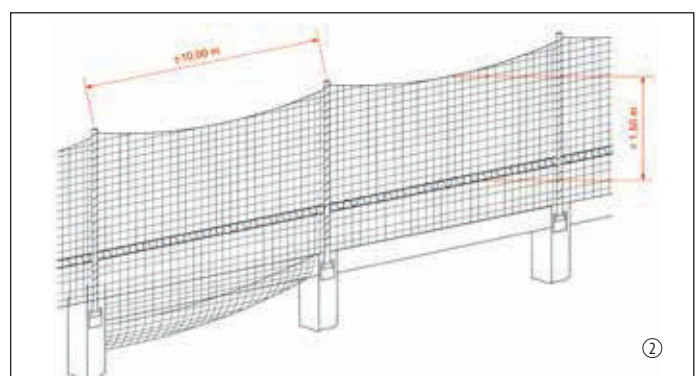
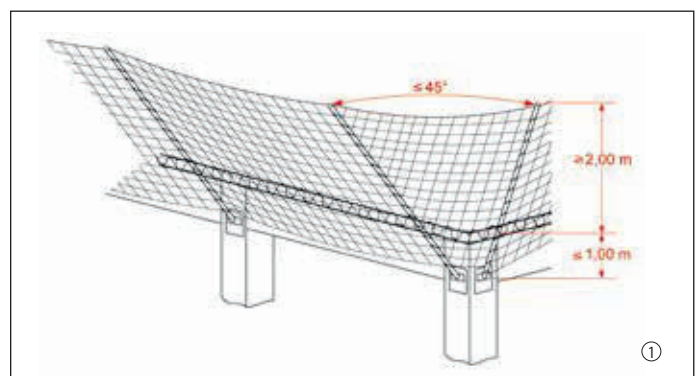



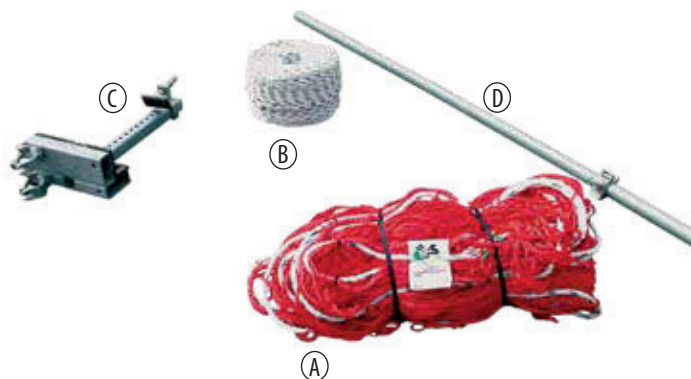

No. 13100 Roof edge protection equipment, complete set



Type (C) + (D) Roof edge protection

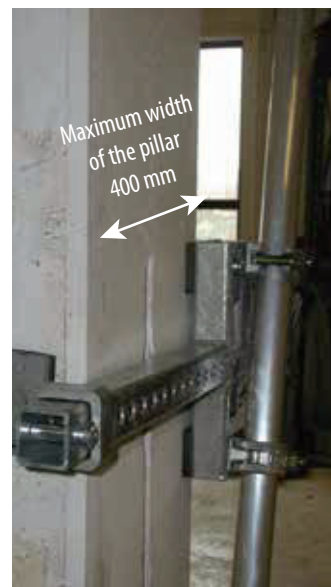

## Roof Edge Protection Equipment

Roof edge protection equipment consisting of:

- (A) **Article 1903-100** Safety net EN 1263-1, system S (see also page 6)
- (B) **Article 2138R-02** Suspension rope EN 1263-1 type M (30 kN), see also p. 16
- (C) + (D) **Article 13100** Protection clamps + Protection holders

Price on request

**If assembling equipment yourself, you must follow the assembly instructions and instructions for use provided with each product.**

### No. 13000 Leasing incl. assembly

In order to ensure that the roof edge protection brackets are properly assembled, we offer a lease option only including assembly!

Price on request/linear metres

**As an alternative to our clamp mounting, article 13100 ((C) + (D)) we also offer the roof edge safety bracket "CLIFF":**

### No. 13200 Roof safety brackets CLIFF for steel comprising:

- 1 x CLIFF adjusting tube comprising pressure piece
- 1 x CLIFF Standard tube bracket
- 2 x CLIFF Clamping jaws for steel
- 2 x CLIFF Safety bolts

Price on request

### No. 13000 optional accessory "Vario"

- 1 x CLIFF tube bracket incl.
- 1 additional safety bolts

Price on request!

### No. 13300 Roof edge safety bracket CLIFF for concrete consisting of:

- 1 x CLIFF wooden/concrete adjusting tube comprising a pressure piece
- 1 x CLIFF Standard tube bracket
- 2 x CLIFF Clamping jaws for wood/concrete
- 2 x CLIFF Safety bolts

Price on request!



No. 13200 Roof safety brackets CLIFF for steel

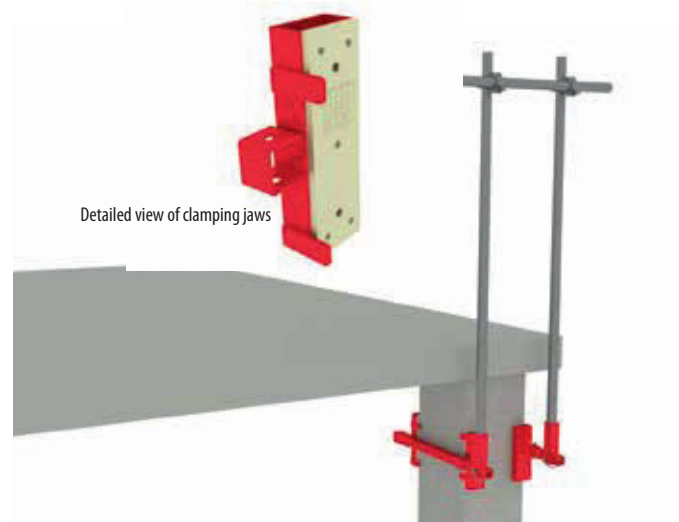

No. 13300 Roof edge safety bracket CLIFF for wood/concrete



①

## Brick guardrail nets/side protection panels for small objects

In order to prevent small objects from falling from scaffolding, we have a range of products.

- ① **Rotproof sheets, permeable to air, made from heavy duty PE knitted panels.**

**No. 720**  
rotproof, air-permeable, UV-stabilised heavy duty knitted panels (approx. 200 g per m<sup>2</sup>). The panels are inclusive of eyelets at 50 cm intervals.  
● Dark Green

- ② **Especially close-meshed side protection nets.**

**No. 2908-030**  
Knotless side protection net made from high tenacity polypropylene, approx. 4 mm thick, mesh size approx. 30 mm. Stitched border rope all round, equipped with Isilink clips 75cm apart. Size: 2 × 10 m.  
● Green

2



①

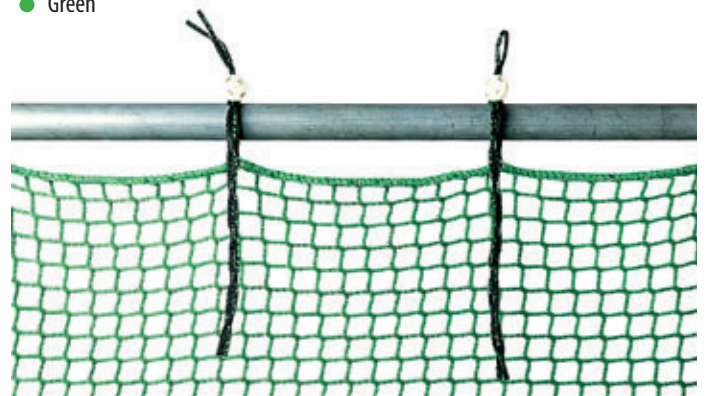

②

**To join sheets together, we recommend:**

**No. 21300**  
6 mm dia. polyethylene rope, loose  
● Green

**To attach the tarpaulins by wrapping around the scaffold pipes, we recommend:**

**No. 21320**  
8 mm dia. nylon rope, loose  
○ White



①

## Dust Protection Nets

① This solution combines a guardrail net to protect workers in the event of a fall with scaffolding panels. The scaffolding panels protect people from small falling objects and dust. The building stands in the middle of a busy pedestrian area.

② Dust protection nets, also known as scaffolding nets in the industry, are an ideal way to protect people from dust and small falling objects. They can be attached to scaffolding quickly and easily. Have a look at the following pages for information about thicknesses and colours.



Photo provided by Netting Now LLC (USA) ②

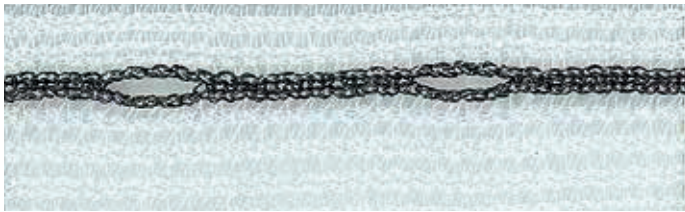

No. 7405-02 resp. 7406-02

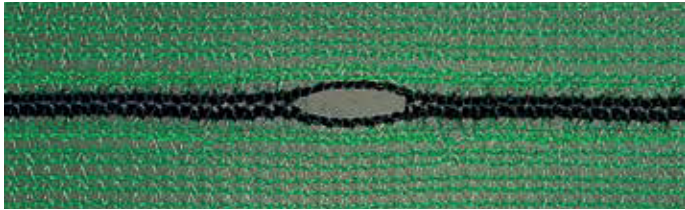

No. 7401-01 to 7404-01

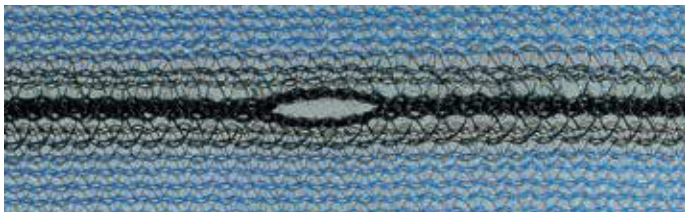

No. 7401-04 to 7404-04



No. 7801-02 resp. 7802-02 (this article is only available in the colour white!)



No. 7205-015

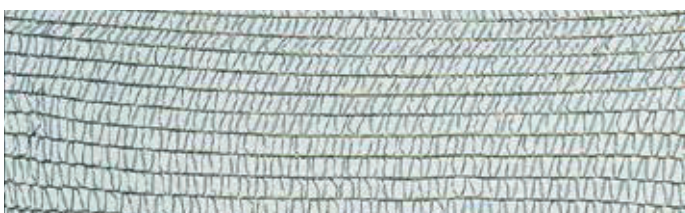

No. 7301-01

**No. 741**

**Fastening clips** for scaffold protection fabric, length 30 cm.

**No. 743**

**Isilink clips** made of approx. 3 mm high tenacity polypropylene, length 30 cm, supplied in bags of 500.

- Green

**No. 744**

**Isilink clips** made of approx. 4 mm high tenacity polypropylene, length 30 cm, supplied in bags of 500.

- Blue

## Scaffold protection netting/dust protection nets/supplied by the roll

Scaffolding nets, light weight, approx. 50 g/m<sup>2</sup>, made of mono-filament high-density polyethylene with eyelets in black. Breaking strength 210 N/5 cm

Size	Weight	Colours	Art.-No.	Price / roll
2.57 x 20 m	app. 50 g/m <sup>2</sup>	● Blue	7307	
3.07 x 20 m	app. 50 g/m <sup>2</sup>	● Blue	7308	

Scaffolding nets, approx. 75 g/m<sup>2</sup>, woven double rib panels made of mono-filament high-density polyethylene with a single strip of polyester yarn along the top and bottom edges and in the middle. Eyelets every 5 cm.

Size	Weight	Colours	Art.-No.	Price / roll
2.57 x 50 m	app. 75 g/m <sup>2</sup>	● Green ○ White ● Blue	7405	
3.07 x 50 m	app. 75 g/m <sup>2</sup>	● Green ○ White ● Blue	7406	

Scaffolding nets, approx. 75 g/m<sup>2</sup>, woven double rib panels made of monofilament high-density polyethylene with a single strip of black polyester yarn along the top and bottom edges and a double strip in the middle. Eyelets every 5 cm.

Size	Weight	Colours	Art.-No.	Price / roll
2.57 x 20 m	app. 75 g/m <sup>2</sup>	● Green ● Blue	7401	
3.07 x 20 m	app. 75 g/m <sup>2</sup>	● Green ● Blue	7402	
2.57 x 10 m	app. 75 g/m <sup>2</sup>	● Green ● Blue	7403	
3.07 x 10 m	app. 75 g/m <sup>2</sup>	● Green ● Blue	7404	

**High dust resistant scaffolding net**, only 10% air permeability, high tear resistance.

Size	Weight	Colours	Art.-No.	Price / roll
2.70 x 50 m	app. 125 g/m <sup>2</sup>	○ White	7801	
3.20 x 50 m	app. 125 g/m <sup>2</sup>	○ White	7802	

**Materials on roll:** scaffold protection netting, flame retardant.

Size	Weight	Colours	Art.-No.	Price / roll
2.70 x 50 m	app. 125 g/m <sup>2</sup>	○ White	7801B	
3.20 x 50 m	app. 125 g/m <sup>2</sup>	○ White	7802B	

**Materials on roll:** scaffolding debris protection netting in UV stabilised polyethylene.

Size	Weight	Colours	Art.-No.	Price / roll
4.10 x 100 m	app. 200 g/m <sup>2</sup>	● Light Green ● Dark Green	7205	
2.95 x 100 m	app. 34 g/m <sup>2</sup>	● Green	7301	

## HUCK tarpaulins ①

Scaffold protection multi-panel tarpaulins with double eyelets, approx. 150 g/m<sup>2</sup>. Surround is reinforced with a polypropylene rope to protect against splitting of tarpaulins. Furthermore, there are double metal eyelets every 50 cm. Further technical data: Breaking strength: approx. 600 N/5 cm, UV-stabilised.

**No. 32001**

Scaffold protection tarpaulin; 2.60 × 10 m

○ White

**No. 32002**

Scaffold protection tarpaulin; 2.60 × 20 m

○ White

**No. 32003**

Scaffold protection tarpaulin; 3.10 × 10 m

○ White

**No. 32004**

Scaffold protection tarpaulin; 3.10 × 20 m

○ White

**No. 741**

Fastening clips for scaffold protection fabric, length 30 cm.



No. 32001–32004 ①

## HUCK tarpaulins ②

Safety tarpaulins for use on scaffolding, approx. 150 g/m<sup>2</sup>, with aluminium eyelets every 100 cm and edged with PP cord. Additional technical data: tensile strength: approx. 750 N/5 cm, UV-stabilised

**No. 35101**

Tarpaulin 6 × 10 m

○ -025: natur

**No. 35102**

Tarpaulin 8 × 10 m

○ -025: natur

**No. 35103**

Tarpaulin 10 × 12 m

○ -025: natur

**No. 35104**

Tarpaulin 10 × 15 m

○ -025: natur



②  
No. 35101–35104

## HUCK tarpaulins, light-weight

Light fabric scaffold protective panels, HDPE with coating approx. 100 g / m<sup>2</sup>, PP cord in hem, aluminium eyelets every 100 cm, tensile strength approx. 365 N/5 cm.

Size	Weight	Colours	Art.-No.	Price / roll
6 × 10 m	app. 100 g/m <sup>2</sup>	○ White	36101	
8 × 10 m	app. 100 g/m <sup>2</sup>	○ White	36102	

## HUCK tarpaulins, flame retardant

Polyband scaffold protective sheeting, flame-retardant EN 13501-1 Class B, PP fabric rolls with LDPE coating approx. 200g/m<sup>2</sup>. All-round eyelet bands, 15 mm eyelets every 10 cm, tensile strength: approx. 560 N/5cm.

Size	Weight	Colours	Art.-No.	Price / roll
6 × 10 m	app. 200 g/m <sup>2</sup>	○ White	35101B1	

## Safety information

### Applications

Guardrail nets are used primarily for roof work. Other areas of application include working on platforms, bridge building, etc. They are used to protect people who fall and fitted to roof scaffolding or at working height on façade scaffolding.

### Applicable standards and net designs

EN 1263-1 and DIN EN 13374 are authoritative for guardrail nets and nets in scaffolding and EN 1263-2 DGUV-I 201-023 for the assembly.

Guardrail nets are classed as safety net system U (Safety net in supporting structures for vertical use). With the use of guardrail nets the crossbeam can be dispensed with.

Mesh size should be 100 mm maximum. The nets are provided with a single strand rope connected all the way around.

### Assembly of guardrail nets

Guardrail nets must be secured to the scaffold rail. They must be kept taut and not allowed to sag. There are various ways of attaching them to the scaffold.

We recommend Isilink clips, which are already sewn into your guardrail net at intervals of no more than 75 cm (in line with regulations).

### ① Safety walls in scaffolding

When there is no guardrail in working areas and pathways on roofs inclined at between 22.5° to 60° during roof work, scaffolding must be set up if the fall protection height from the eaves is more than 2 m.

For high roofs with a height difference of more than 5 m additional roof safety walls must be affixed to the roof area. Safety nets EN 1263-1 can be used as a safety wall within roof scaffolding.

### Storage/warning

Store in a dry place. Never store near a heat source. Do not allow contact with abrasive substances such as acids or bases. Do not expose to direct UV radiation. Nets and ropes should not be dragged over sharp edges. Objects that fall into the net are to be removed immediately as they could injure people who fall onto them and impair the net's load-bearing capacity.

### Repairs/defects

Damaged nets may only be repaired by suitably qualified staff at the manufacturer's plant. If defects are found, protective nets may only continue to be used if a qualified person agrees or they must be correctly repaired. To use the nets in extreme temperatures below -20°C or above 50°C, please consult the manufacturer.

### Faulty nets

Faulty nets (damaged mesh, defective rope edging) or nets that have already been used to break a fall must be withdrawn until they have been tested by the manufacturer or someone with appropriate specialist knowledge. Repairs may only be undertaken by such specialists.

### Labelling

Every guardrail net must be labelled clearly in accordance with EN regulations. The label must include the following information:

- Date of manufacture and name of manufacturer
- Net type in accordance with EN 1263-1
- Precise item designation (item number)
- Minimum energy absorption capacity or minimum tensile load of test mesh in accordance with ISO 1806
- Number of the inspection authority that certified the net

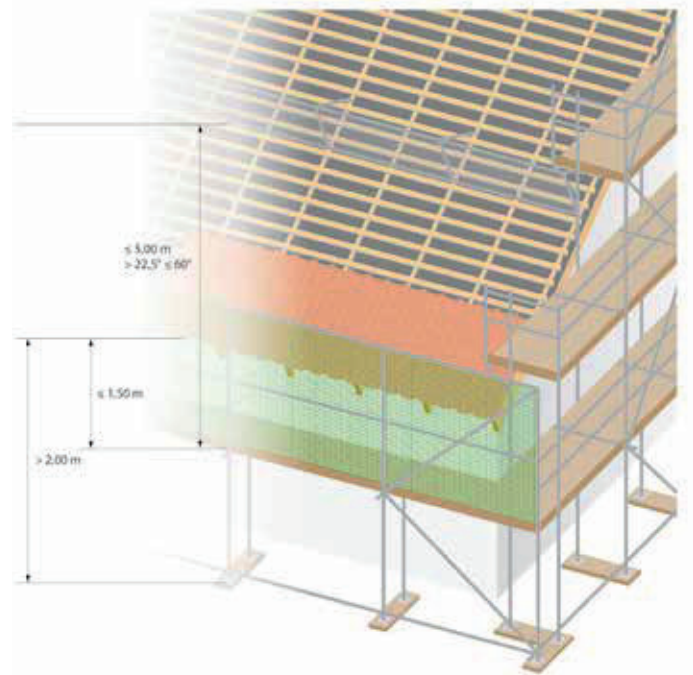

①



②



③

### ② + ③ Annual inspection

On every guardrail net, there are lead seals with the same identity number on the safety net label and test mesh (see photo 3). This ensures that the safety net and test mesh belong together. No more than 1 year after the date of manufacture, the first test mesh must be sent to an authorised tester (e.g. the manufacturer). This tester verifies whether the net still has the necessary strength/energy absorption capacity and produces documentary evidence of the results.

### No. 9700 Net cost of inspection per test mesh:

If the test results are positive, you will receive a new test badge bearing the identity number, which you then attach to the relevant net (see photo 2).

## Technical Details

Art.-No.	Description	Colours	Material dia (mm) app.	Mesh size (mm) app.	Weight g/m <sup>2</sup> app.	Maximum tensile strength of mesh (kN)
200-020	Polypropylene, ht., knotless	● ● ● ●	2.3	20	180	0.80
200-030	Polypropylene, ht., knotless	○ ●	2.3	30	135	0.80
200-035	Polypropylene, ht., knotless	○ ●	2.3	35	135	0.80
200-045	Polypropylene, ht., knotless	● ● ○ ● ●	2.3	45	90	0.80
200-100	Polypropylene, ht., knotless	● ○ ● ●	2.3	100	50	0.80
200-120	Polypropylene, ht., knotless	● ● ○ ●	2.3	120	35	0.80
201-020	Polypropylene, ht., knotless	○ ●	1.8	20	130	0.60
201-025	Polypropylene, ht., knotless	● ●	1.8	25	100	0.60
201-030	Polypropylene, ht., knotless	●	1.8	30	85	0.60
1202-020	Polypropylene, ht., knotless	○ ● ●	1	20	50	0.20
1202-030	Polypropylene, ht., knotless	○ ● ●	1	30	30	0.20
1202-050	Polypropylene, ht., knotless	○ ● ●	1	50	20	0.20
1203-010	Polypropylene, ht., knotless	● (diagonal)	1.5	10	150	0.25
203-020	Polypropylene, ht., knotless	●	1.5	20	80	0.25
203-030	Polypropylene, ht., knotless	○ ●	1.5	30	50	0.25
203-050	Polypropylene, ht., knotless	●	1.5	50	35	0.25
203-060	Polypropylene, ht., knotless	●	1.5	60	30	0.25
203-100	Polypropylene, ht., knotless	●	1.5	100	15	0.25
205-100	Polypropylene, ht., knotless	●	2.8	100	60	1.00
205-120	Polypropylene, ht., knotless	●	2.8	120	50	1.00
207-045	Polypropylene, ht., knotless	● ●	3.5	45	200	1.40
207-100	Polypropylene, ht., knotless	● ●	3.5	100	100	1.40
207-120	Polypropylene, ht., knotless	● ●	3.5	120	70	1.40
209-030	Polypropylene, ht., knotless	●	3	30	260	1.10
209-045	Polypropylene, ht., knotless	● ● ○ ● ● ● ● ● ●	3	45	148	1.10
209-100	Polypropylene, ht., knotless	● ● ○ ● ●	3	100	75	1.10
209-120	Polypropylene, ht., knotless	● ○ ● ●	3	120	65	1.10
210-035	Polyester, knotless	○	4	35	350	2.00
210-045	Polyester, knotless	○	4	45	285	2.00
210-100	Polyester, knotless	○	4	100	150	2.00
210-120	Polyester, knotless	○	4	120	100	2.00
212-045	Polypropylene, ht., knotless	● ○ ● ● ● ● ●	5	45	400	3.00
212-050	Polypropylene, ht., knotless	○	5	50	350	3.00
212-060	Polypropylene, ht., knotless	● ● ● ●	5	60	300	3.00
212-070	Polypropylene, ht., knotless	● ●	5	70	275	3.00
212-100	Polypropylene, ht., knotless	● ○ ● ● ● ● ● ● ●	5	100	200	3.00
212-120	Polypropylene, ht., knotless	● ○	5	120	170	3.00
212-300	Polypropylene, ht., knotless	●	5	300	55	3.50
213-100	Polypropylene, ht., knotless	○	6	100	360	4.20
214-045	Polypropylene, ht., knotless	●	4.2	45	235	1.80
215-030	Polypropylene, ht., knotless	● ●	4	30	330	1.60
215-045	Polypropylene, ht., knotless	● ○ ● ● ● ●	4	45	210	1.60
215-100	Polypropylene, ht., knotless	● ○ ● ● ● ● ● ●	4	100	110	1.60
215-120	Polypropylene, ht., knotless	● ○ ● ● ● ●	4	120	90	1.60
216-035	Polyester, knotless	○	3	35	230	1.25
216-045	Polyester, knotless	○	3	45	185	1.25
216-100	Polyester, knotless	○	3	100	90	1.25
216-130	Polyester, knotless	○	3	130	70	1.25
1903-045	Polypropylene, ht., knotless	● ○ ● ● ●	5	45	475	3.00
1903-060	Polypropylene, ht., knotless	● ● ●	5	60	375	3.00
1903-100	Polypropylene, ht., knotless	● ○ ● ● ● ● ● ● ●	5	100	275	3.00
2003-100	Polypropylene, ht., knotless	● ○ ● ● ● ● ● ● ●	5	100	300	3.00
2007-020	Polypropylene, ht., knotless	○ ●	1.8	20	170	0.60
3000-045	Polypropylene, ht., knotless	● ○ ● ● ● ●	5	45	450	3.00
3000-060	Polypropylene, ht., knotless	● ●	5	60	350	3.00
3000-100	Polypropylene, ht., knotless	● ○ ● ● ● ● ●	5	100	250	3.00

## Specifications

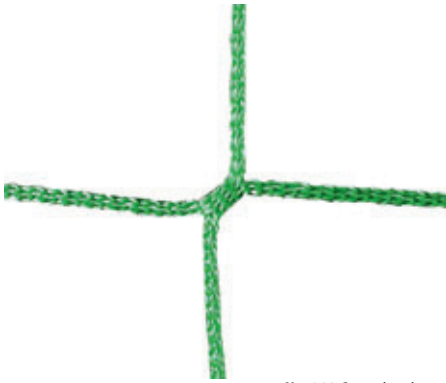

**No. 200** Green, knotless,  
high tenacity polypropylene,  
approx. 2.3 mm dia.



**No. 200** White, knotless,  
high tenacity polypropylene, approx. 2.3 mm dia.

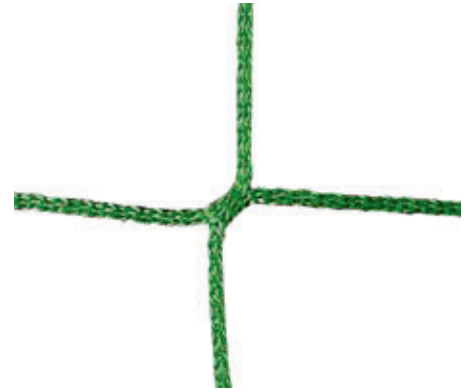

**No. 200** Dark Green, knotless,  
high tenacity polypropylene, approx. 2.3mm dia.

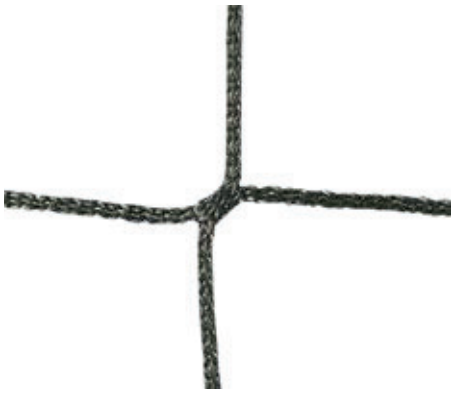

**No. 200** Black, knotless,  
high tenacity polypropylene, approx. 2.3 mm dia.



**No. 201** Black, knotless  
high tenacity polypropylene, approx. 1.8 mm dia.



**No. 201** White, knotless  
high tenacity polypropylene, approx. 1.8 mm dia.



**No. 203** Black, knotless  
high tenacity polypropylene, approx. 1.5 mm dia.

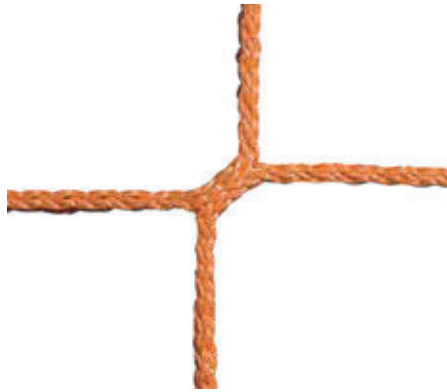

**No. 205** Orange, knotless  
high tenacity polypropylene, approx. 2.8 mm dia.

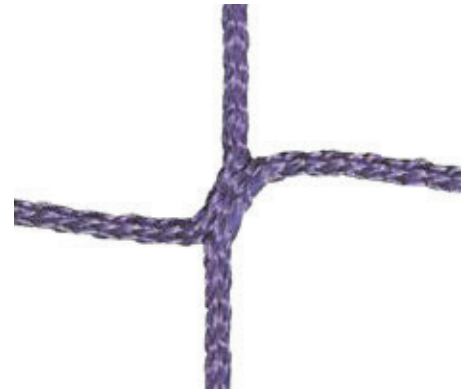

**No. 207** Violet, knotless,  
high tenacity polypropylene, approx. 3.5 mm dia.

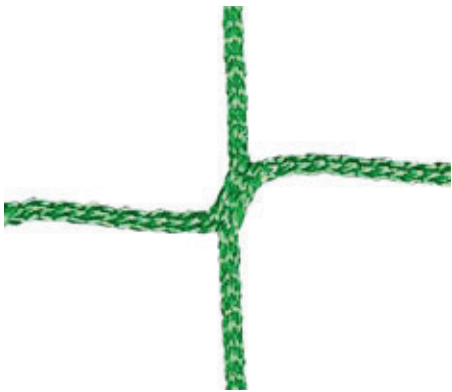

**No. 209** Green, knotless,  
high tenacity polypropylene, approx. 3 mm dia.



**No. 209** White, knotless,  
high tenacity polypropylene, approx. 3 mm dia.

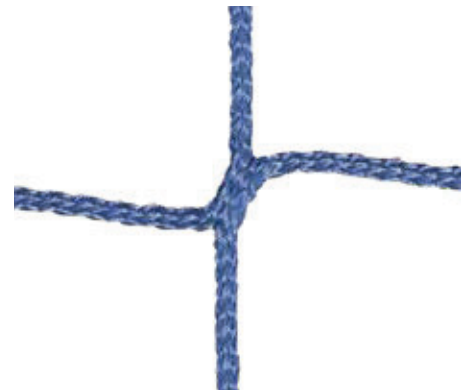

**No. 209** Blue, knotless,  
high tenacity polypropylene, approx. 3 mm dia.



## Specifications



**Nr. 209** Black, knotless,  
high tenacity polypropylene, approx. 3 mm dia.



**No. 210** White, knotless,  
polyester, approx. 4 mm dia.

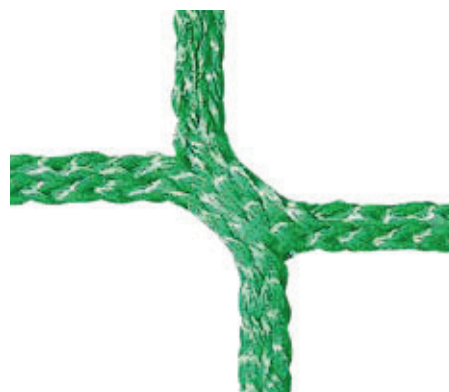

**No. 212** Green, knotless,  
high tenacity polypropylene, approx. 5 mm dia.



**No. 212** White, knotless,  
high tenacity polypropylene, approx. 5 mm dia.



**No. 212** Orange, knotless,  
high tenacity polypropylene, approx. 5 mm dia.



**No. 212** Blue, knotless,  
high tenacity polypropylene, approx. 5 mm dia.



**No. 212** Black, knotless,  
high tenacity polypropylene, approx. 5 mm dia.



**No. 212** Red, knotless,  
high tenacity polypropylene, approx. 5 mm dia.



**No. 213** White, knotless  
high tenacity polypropylene, approx. 6 mm dia.



**No. 215** Green, knotless,  
high tenacity polypropylene, approx. 4 mm dia.



**No. 215** Yellow, knotless  
high tenacity polypropylene, approx. 4 mm dia.

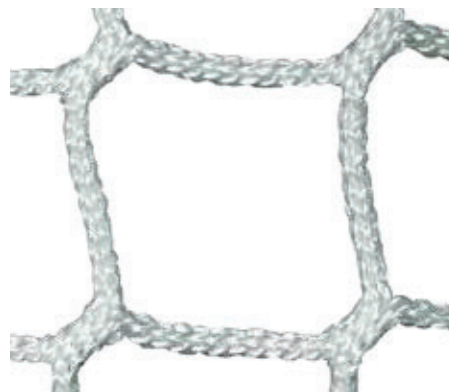

**No. 216** White, knotless  
Polyester, approx. 3 mm dia.

## Material Thickness From 1 - 3 mm

Art.-No.	Description	Material Ø approx. mm	Mesh size approx. mm	Colours	Price/m <sup>2</sup> €
1202-020	PP, high tenacity, knotless **	1	20	○ ● ●	
1202-030	PP, high tenacity, knotless **	1	30	○ ● ●	
1202-050	PP, high tenacity, knotless **	1	50	○ ● ●	
1203-010	PP, high tenacity, knotless ***	1.5	10	● (diagonal)	
203-020	PP, high tenacity, knotless	1.5	20	●	
203-028	PP, high tenacity, knotless	1.5	28	●	
203-030	PP, high tenacity, knotless	1.5	30	○ ●	
203-050	PP, high tenacity, knotless	1.5	50	● (whilst stocks last)	
203-060	PP, high tenacity, knotless	1.5	60	●	
203-100	PP, high tenacity, knotless	1.5	100	●	
201-020	PP, high tenacity, knotless	1.8	20	○ ●	
201-025	PP, high tenacity, knotless	1.8	25	● ●	
201-030	PP, high tenacity, knotless	1.8	30	●	
200-020	PP, high tenacity, knotless	2.3	20	● ● ● ●	
200-025	PP, high tenacity, knotless	2.3	25	●	
200-030	PP, high tenacity, knotless	2.3	30	○ ●	
200-035	PP, high tenacity, knotless	2.3	35	○ ●	
200-045	PP, high tenacity, knotless	2.3	45	● ● ○ ● ●	
200-100	PP, high tenacity, knotless	2.3	100	● ○ ● ●	
200-120	PP, high tenacity, knotless	2.3	120	● ● ○ ●	
205-100	PP, high tenacity, knotless	2.8	100	●	
205-120	PP, high tenacity, knotless	2.8	120	●	
209-030	PP, high tenacity, knotless	3	30	●	
209-045	PP, high tenacity, knotless	3	45	● ● ○ ● ● ● ● ● ● ●	
209-100	PP, high tenacity, knotless	3	100	● ● ○ ● ●	
209-120	PP, high tenacity, knotless	3	120	● ○ ● ●	
216-035	Polyester, knotless	3	35	○	
216-045	Polyester, knotless	3	45	○	
216-100	Polyester, knotless	3	100	○	
216-130	Polyester, knotless	3	130	○	

## Nets made of Polyamid

**NEW**

204-020	Polyamid, knotless	2	20	●	
208-038	Polyamid, knotless	3.5	38	●	
219-050	Polyamid, knotless	4.5	50	●	
219-100	Polyamid, knotless	4.5	100	●	

\*\* Art. No. 1202-020 to 1202-050 cut only edges. \*\*\* Art. No. 1203-010 in Black = diamond mesh configuration, cut only edges.

**Surcharge for small quantities:** under 1 m<sup>2</sup> +200 %, under 5 m<sup>2</sup> +100 % under 10 m<sup>2</sup> +35% per net, under 20 m<sup>2</sup> +20% per net. The surcharge is based on the size of a single net, and not on the total order.

For loose hanging nets (curtain nets) the length should be longer than the surface to be covered depending on the mesh size of the net: a) up to 45 mm mesh size + 20% b) 50 - 100 mm mesh size + 15% c) 110 - 150 mm mesh size + 10%

For external use, polypropylene is recommended. All nets are fitted with a reinforced selvedge cord of approx. 5 - 7 mm dia. inclusive in the price per m<sup>2</sup>, except 1202 and 1203-010. These are cut only.

## Material Thickness From 3.5 - 6 mm

Art.-No.	Description	Material Ø approx. mm	Mesh size approx. mm	Colours	Price/m <sup>2</sup> €
207-045	PP, high tenacity, knotless	3.5	45	● ● ****	
207-100	PP, high tenacity, knotless	3.5	100	● ● ****	
207-120	PP, high tenacity, knotless	3.5	120	● ● ****	
210-035	Polyester, knotless	4	35	○	
210-045	Polyester, knotless	4	45	○	
210-100	Polyester, knotless	4	100	○	
210-120	Polyester, knotless	4	120	○	
215-030	PP, high tenacity, knotless	4	30	● ●	
215-045	PP, high tenacity, knotless	4	45	● ○ ● ● ● ● ● ●	
215-100	PP, high tenacity, knotless	4	100	● ○ ● ● ● ● ● ● ● ●	
215-120	PP, high tenacity, knotless	4	120	● ○ ● ● ● ● ● ●	
214-045	PP, high tenacity, knotless	4.2	45	●	
211-045	Polyester, knotless	4.5	45	●	
212-030	PP, high tenacity, knotless	5	30	● ●	
212-045	PP, high tenacity, knotless	5	45	● ○ ● ● ● ● ● ● ● ●	
212-060	PP, high tenacity, knotless	5	60	● ● ● ● ● ●	
212-070	PP, high tenacity, knotless	5	70	● ●	
212-100	PP, high tenacity, knotless	5	100	● ○ ● ● ● ● ● ● ● ● ● ●	
212-120	PP, high tenacity, knotless	5	120	● ○	
212-300	PP, high tenacity, knotless	5	300	●	
213-100	PP, high tenacity, knotless	6	100	○	

\*\*\*\* Art.-No. 207 in Violet: while stocks last

## Material thickness 15 mm (Mahulan)

Art. No.	Description*	Material dia. (mm) app.	Mesh size (mm) app.	Colours	Price/m <sup>2</sup> €
4415-130	PP, knotless.	15.0	130	● ●	

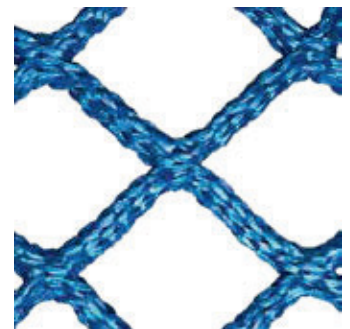

No. 4415-130 blue, knotless, polypropylene, approx. 15 mm dia.

## Colour table

- = 01 = green
- = 015 = dark green
- = 02 = white
- = 03 = orange
- = 04 = blue
- = 05 = yellow
- = 06 = black
- = 07 = red
- = 08 = hemp colour
- = 09 = violet
- = 65 = gray

When ordering, please indicate the colour number!

Example Article No.: e.g. 209-045-01

/                      |                      \  
 Specification   Mesh size   Colour

If square mesh nets are required it is **technically impossible to supply all net sizes without a seam.**

All nets are manufactured with diagonal mesh to the greatest possible width and then converted to square mesh.

**The resulting seams cannot be avoided for technical reasons and do not reduce the quality of the net.**

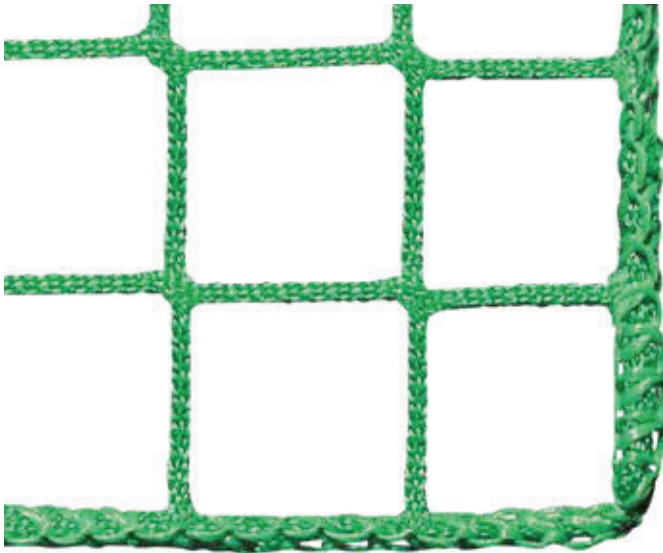

①



②

## Standard Rack Safety Nets

Safety nets, metre lengths in 5 m widths. Lengths: all

### No. 2140-120

High tenacity polypropylene, approx. 3 mm dia., approx. 120 mm mesh.

- Green

### No. 2142-120

High tenacity polypropylene, approx. 4 mm dia., approx. 120 mm mesh.

- Green

① All nets have a reinforced edge of approx. 5 - 7 mm dia., which is included in the m<sup>2</sup> price (see photo).

If square mesh nets are required it is **technically impossible to supply all net sizes without a seam.**

All nets are manufactured with diagonal mesh to the greatest possible width and then converted to square mesh.

**The resulting seams cannot be avoided for technical reasons and do not reduce the quality of the net.**

### Surcharge for small quantities:

Nets under 1 m<sup>2</sup> + 200% per net

Nets under 5 m<sup>2</sup> + 100% per net

Nets under 10 m<sup>2</sup> + 35% per net

Nets under 20 m<sup>2</sup> + 20% per net

*The surcharge is based on the size of a single net, and not on the total order.*

For quality and colours of our safety and industrial nets see pages 42 and 43.

## Netting accessories

### Net surround cords attached to net

#### No. 2130 polyethylene rope, 6 mm dia

- Green ● Orange ● Black

#### No. 2131 nylon rope, 5 mm dia

- White

#### No. 2132 nylon rope, 8 mm dia

- White

#### No. 2136 nylon rope, 12 mm dia

- White

### Net surround cords loose

#### No. 21300 polyethylene rope, 6 mm dia

- Green ● Orange ● Black

#### No. 21310 nylon rope, 5 mm dia

- White

#### No. 21320 nylon rope, 8 mm dia

- White

#### No. 21360 nylon rope, 12 mm dia

- White

② Safety nets are a reliable way to prevent pallets from sliding through racks during loading.

### For weighting our nets,

a lead cord encased in webbing and attached to the net:

**No. 2110** Weight 400 g per metre.

**No. 2111** Weight 200 g per metre.

**No. 2112** Lead cord weighting, 200 g per metre, attached to the net without webbing.

## Accessories

All safety nets can be equipped as follows:

### For suspending the nets:

and so that they slide more easily aside on the steel wire rope:

#### No. 2122

open rings made from nylon, 9 mm dia., 53 mm long, 30 mm wide, inner length 35 mm, Colour ● Black, 3 rings per metre of netting

#### No. 2123

open nylon rings, loose

### or additional protection

and securing the nets to existing borders or tape surrounds:

#### No. 2116

Net surround made of polyester webbing, 50 mm wide.

○ White



No. 2116



No. 2100

No. 2118

To suspend and stretch the safety nets, we recommend our galvanised steel wire ropes, which are fitted on both ends with loops and tensioners.

#### No. 2100

Steel wire rope, M 10, galvanised, 6 mm dia.

#### No. 2101

Additional: loops on both ends and tensioner for 6 mm rope, M10.

#### No. 2102

Steel wire rope, galvanised, 4 mm dia.

#### No. 2103

Additional: loops on both ends and tensioner for 4 mm rope, M10.

#### No. 2097

Steel wire cable, M 10, PVC-coated, 5/7 mm thick.

#### No. 2099

Steel wire cable, M8, PVC-coated, 4/5 mm thick.

#### No. 2098

Steel wire cable, M8, PVC-coated, 3/4 mm thick.

#### No. 2118

Turnbuckle M 10, fork/fork with 2 thimbles and 4 wire rope clips



No. 2101

No. 2123

### Ground Anchor

Consisting of a wire rope (steel or high-grade steel) of approx. 3 mm diameter, 40 cm long with swaged loops. With the aid of a 45 cm long round iron (nail) it can be hammered into the ground and then removed.

By pulling the steel rope by the loop, the anchor positions itself slantwise in the ground and thereby becomes extremely firmly attached. Load resistance approx. 100 kg

**No. 21091** with high-grade steel cable

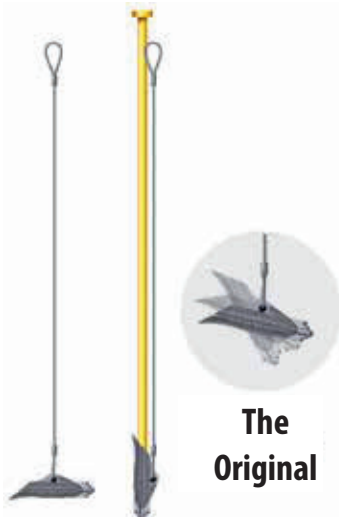

The Original



1 Hammer the connecting rods to drive the ground anchor into the ground.



2 Pull out the connecting rod.



3 Pull back the anchor rope using the lock hooks to „lock“ the ground anchor.



4 The ground anchor can now be wholly used as a hold point.



## Pallet Rack Nets

Pallet rack nets are primarily used for pallet racks that are to be loaded and unloaded on a single side. They protect people walking past from falling goods. We offer nets in various diameters, depending on the weight and size of the goods to be secured.

### No. 3011 Strap with locking buckle

Sold individually, and not attached to the net.

● Green, ● Blue

### No. 2100 Steel wire rope

galvanised, 6 mm dia

### No. 2101

Additional two-ended thimble and turnbuckle

### No. 2106 M10 ring bolt

with washer and nut

### No. 2107 M10 ring bolt

### No. 2108 Beam clamp

loose, clamping range 20 mm.

### No. 2018 Snap hook,

loose, 60 x 6 mm, galvanised

### No. 2171 Spacer,

173 mm. consisting of 1 spacer, 2 brackets, 4 nuts, 4 washers



No. 3011-04



No. 3011-01

### Pallet-rack net in high-tenacity polypropylene

Mesh size	Material dia.	Colours*	Art.-No.	Price / m <sup>2</sup>
100 mm	5 mm	● Green ● Blue ● Black	212-100	
45 mm	5 mm	● Green ● Blue ● Black	212-045	
45 mm	3 mm	● Green ● Blue ● Yellow ● Black	209-045	
25 mm	1.8 mm	● Black	201-025	

\* for colour codes and surcharge for small nets see page 43.

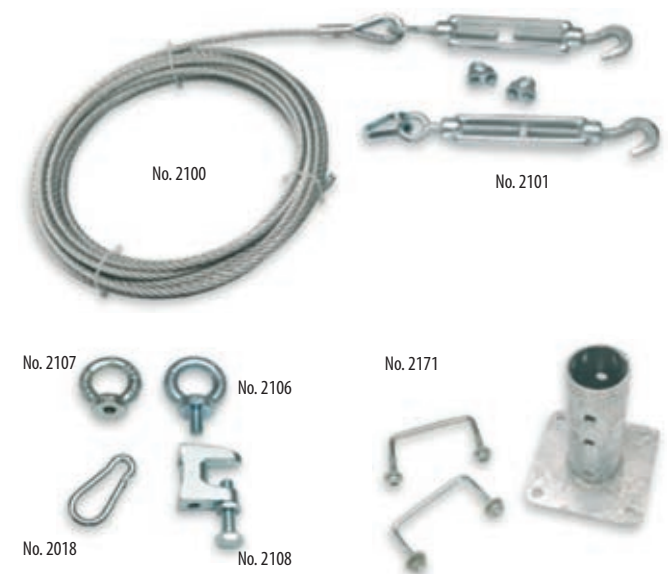



## Assembly instructions on small rack safety nets

In the new DGVU 101-011 Safety nets information sheet in Annex 2 there are also rules laid down for the assembly of horizontal high pallet rack safety nets.

### Area of application

High pallet rack safety nets protect persons, whose fall cannot be prevented, from injuries as a result of a high fall when working at workplaces and traffic routes of pallet rack storage.

### Components

Pallet rack storage safety nets comprise: A net complying with net category A1 in accordance with DIN EN 1263-1, a reinforced top of the net, however with a mesh width of no bigger than 45 mm, a steel rope with a minimum diameter of 6 mm, fastener between reinforced top of the net and steel rope such as snap hook or shackle with sufficient tensile strength and a cable tensioner with a tensile force suitable for the rope diameter.

### Dimensions

The smallest area of the pallet rack safety net must be at least 2 m<sup>2</sup>. For rectangular safety nets the length of the shortest side must be at least 1.0 m.

### Height of fall

Preferably pallet rack safety nets are to be attached at the same height as the work places and traffic routes being protected. The difference in height must not exceed 0.10 m.

### Attachment

The gap between the suspension points to attach the steel rope e.g. with ring eye-lets, must not be larger than 1.0 m. Pallet rack safety nets can be attached to suspension points using snap hooks or shackles, for example. For measuring the suspension points a characteristic load P of 6 kN as a result of a fall with an angle of  $\alpha = 45^\circ$  must be adopted. For measuring the building components three characteristic loads of 4 kN, 6 kN and 4 kN are taken into account at unfavourable points.

### Connections

When pallet rack safety nets are connected, then joining rope are used in such a way that the space between the join is not more than 45 mm and the nets cannot be moved by more than 45 mm from one another.

### Ageing tests

The manufacturer has incorporated test meshes into pallet rack safety nets, in order to be able to detect reduced stability in the net yarn as a result of ageing. To this end proof must be provided in which at least 5 test meshes from a net area of 1000 m can be taken from various points that are exposed to UV.

During the annual testing it must be confirmed by a testing body or the manufacturer that the minimum energy absorption/minimum mesh stability does not fall below the value specified by the manufacturer. The test method (generally ISO 1806) is documented in EN 1263-1.





## Mining barrier nets for loose rocks

To meet the requirements of the mining industry, these nets have an antistatic finish.

**Barrier net**, made from high-tenacity polypropylene, approx. 6 mm dia., **diamond mesh**, with a 12 mm nylon rope edging, antistatic finish. HUCK barrier nets conform to Bau BG and mining-industry safety regulations

Mesh size	Mesh type	Material dia.	Colours	Art.-No.	Price / m <sup>2</sup>
100 mm	diamond	6 mm	○ White	2500-100	
50 mm	square	6 mm	○ White	2510-050	

### No. 2017

**Additional charge** for extra thimbles, incorporated into the rope edge.

### No. 2019

**Additional charge** for rope loops, incorporated into the rope edge.

If you would like a non-rectangular net, please ask us for a quote.

### Surcharge for small quantities:

Nets under 1 m<sup>2</sup> + 200% per net

Nets under 5 m<sup>2</sup> + 100% per net

Nets under 10 m<sup>2</sup> + 35% per net

Nets under 20 m<sup>2</sup> + 20% per net

*The surcharge is based on the size of a single net, and not on the total order.*

- = 01 = green      ○ = 02 = white      ● = 06 = black
- = 015 = dark green      ● = 04 = blue      ● = 07 = red

Example Article No.: 200F-045-02  
 Specification    Mesh size    Colour

## Safety and stop nets / fall-arrest nets with flame-retardant finish

We offer some of our safety nets with an integral flame-retardant finish. This ensures that they retain their flame-retardant properties, even when used outside in any type of weather.

The nets have been tested in compliance with and fulfil the requirements of DIN 4102 or EN 13501-1.

### Safety net in high-tenacity polypropylene, no rope edging, integral fire-retardant finish

Mesh size	Material dia.	Colours	Art.-No.	Price / m <sup>2</sup>
25 mm	2.3 mm	● Dark green ○ White	200F025	
45 mm	2.3 mm	● Dark green ○ White ● Blue ● Black	200F045	
45 mm	3 mm	● Green ○ White ● Blue ● Black	209F045	
45 mm	5 mm	● Green ○ White ● Black	212F045	
60 mm	5 mm	● Black	212F060	
100 mm	5 mm	● Green ○ White	212F100	

### Safety net in high-tenacity polypropylene, with a 12mm, 30-kN nylon rope edging, integral fire-retardant finish

Mesh size	Material dia.	Colours	Art.-No.	Price / m <sup>2</sup>
45 mm	5 mm	● Green	1903F045	
60 mm	5 mm	● Black	1903F060	
100 mm	5 mm	● Green	1903F100	

### No. 1800 Supplementary flame-retardant finish

Flame-retardant impregnation.

Price on request

### No. 1900 Stiff, water-repellent finish

Water-repellent impregnation, stiff.

Price on request





①

## Load-carrying nets

### Description:

① Knotless net conforming to EN 1263-1 in high-tenacity polypropylene. With nylon rope edging and four abrasion-resistant loops at the corners. Additionally equipped with two cross ropes running around the net and attached to the upper edging rope (for easier loading).

Mesh size	Size m	App dia.	Load capacity	Colours	Art.-No.	Price / each
60 mm	4 × 4	5 mm	1 t	● Green	2061-060	
100 mm	4 × 4	6 mm	2 t	○ White	2060-100	

## Load-carrying nets (heavy-duty version)

### Description:

Knotless net conforming to EN 1263-1 in high-tenacity polypropylene. With 16-mm nylon rope edging and four abrasion-resistant loops at the corners. Additionally equipped with two cross ropes running around the net (14-mm PA) and attached to the upper edging rope (for easier loading).

Mesh size	Size m	App dia.	Load capacity	Colours	Art.-No.	Price / each
130 mm	3.3 × 3.3	15 mm	3 t	● Green	2062-130	

## Load-carrying nets (especially tear-resistant design)

### Description:

② Load carrying nets in PE in selvedge/selvedge design, approx. 8 mm thick, with reinforced wear resistance. With 16 mm nylon edge rope and 4 abrasion resistant loops at the corners. Additionally with 2 cross ropes running round the net (PA 14 mm), which are attached to the upper edging rope (for easier loading).

Mesh size	Size	App dia.	Load capacity	Colours	Art.-No.	Price / each
100 mm diamond	4 × 4 m	8 mm	3.5 t	● Black	2066-106	



②



③

### ③ No. 2064

#### Polyester load cable, 4-strand

Cable size 40 mm, cable width 10 mm. Effective length 2 m. Three-part ring above, eyehooks below. Suitable for load-carrying nets no. 2060 – 2062 and 2066. Load-bearing capacity at 0°–45° = 3.4 t. Load-bearing capacity at 45°–60° = 2.4 t.

● Red



①



②



③



④

## Lifting Loads

①—③

An easy and convenient way to lift building material and other similar items quickly. Simply spread the net out on the ground (**photo 1**), place the load to be lifted on top of it and then hook the rope edge into the suspension frame. Depending on your choice of net, loads of up to 2 t can be lifted.

②

### Nets for securing goods

Used here to secure roof tiles for transportation (photo supplied by Probst). They can also be used for careful transportation of goods that are too small for grippers. We recommend:

**No. 1903-045/-060/-100**  
(see page 4)



Trailer/ Truck size	Sheet/ Net size
1.30 × 2.50 m	2.00 × 3.00 m
1.50 × 3.00 m	2.50 × 3.50 m
2.00 × 2.70 m	3.00 × 3.50 m
2.20 × 3.60 m	3.00 × 4.00 m

## Cover nets for trailers/flatbed trucks

### standard sizes

#### Description:

Knotless safety net in high-tenacity polypropylene with reinforced selvedge cord.

Square mesh. Edged all round with 6mm shock cord.

Mesh size	Net size	Material dia	Colours	Art.-No.	Price / each
30 mm	2 m × 3 m	1.8 mm	● Black	2350-030	
45 mm	2 m × 3 m	3 mm	● Green	2360-045	
100 mm	2 m × 3 m	4 mm	● Green	2370-100	

Mesh size	Net size	Material dia	Colours	Art.-No.	Price / each
30 mm	2.50 m × 3.50 m	1.8 mm	● Black	2351-030	
45 mm	2.50 m × 3.50 m	3 mm	● Green	2361-045	
100 mm	2.50 m × 3.50 m	4 mm	● Green	2371-100	

Mesh size	Net size	Material dia	Colours	Art.-No.	Price / each
30 mm	3 m × 3.50 m	1.8 mm	● Black	2352-030	
45 mm	3 m × 3.50 m	3 mm	● Green	2362-045	
100 mm	3 m × 3.50 m	4 mm	● Green	2372-100	

Mesh size	Net size	Material dia	Colours	Art.-No.	Price / each
30 mm	3 m × 4 m	1.8 mm	● Black	2353-030	
45 mm	3 m × 4 m	3 mm	● Green	2363-045	
100 mm	3 × 4 m	4 mm	● Green	2373-100	



## Cover nets with alternating colour pattern

### European patent no. 22 85 456

New machine technology means that we can also offer cover nets with hexagonal mesh and **alternating** colour patterns. The pattern we have chosen in red/black should improve the visibility of the load-securing nets

#### No. 3360-045-67

Knotless load-securing net, approx. 3.5 mm high-tenacity polypropylene, approx. 45 mm hexagonal mesh (chequered pattern).

Net size: 2 x 3 m, including shock cord

#### No. 33301-045-67

Knotless container cover net, approx. 3.5 mm high-tenacity polypropylene, approx. 45 mm hexagonal mesh (**chequered pattern**).

Net size: 3 x 5 m, including shock cord

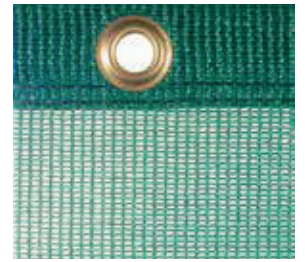

200 g/m<sup>2</sup> Quality



240 g/m<sup>2</sup> Quality

## Air-permeable plastic tarpaulins for trailers/ flatbed trucks

### Standard sizes

Description:  
UV-stabilised, air-permeable knitted fabric with reinforced edge and eyelets every 0.50 m. Edged all round with 6 mm shock cord.

Trailer/ Truck size	Sheet/ Net size
1.30 x 2.50 m	2.00 x 3.00 m
1.50 x 3.00 m	2.50 x 3.50 m
2.00 x 2.70 m	3.00 x 3.50 m
2.20 x 3.60 m	3.00 x 4.00 m

Sheet size	Weight app. g/m <sup>2</sup>	Material	Colours	Art.-No.	Price / each
2 x 3	200 g/m <sup>2</sup>	PE tape	● Black	7213-015	
2 x 3	240 g/m <sup>2</sup>	PE tape	● Green	7613-06	

Sheet size	Weight app. g/m <sup>2</sup>	Material	Colours	Art.-No.	Price / each
2.50 x 3.50	200 g/m <sup>2</sup>	PE tape	● Black	7214-015	
2.50 x 3.50	240 g/m <sup>2</sup>	PE tape	● Green	7614-06	

Sheet size	Weight app. g/m <sup>2</sup>	Material	Colours	Art.-No.	Price / each
3 x 3.50	200 g/m <sup>2</sup>	PE tape	● Black	7215-015	
3 x 3.50	240 g/m <sup>2</sup>	PE tape	● Green	7615-06	

Sheet size	Weight app. g/m <sup>2</sup>	Material	Colours	Art.-No.	Price / each
3 x 4	200 g/m <sup>2</sup>	PE tape	● Black	7216-015	
3 x 4	240 g/m <sup>2</sup>	PE tape	● Green	7616-06	

## Screw-in steel cover hooks

Hook opening	Art.-No.	Price / each
11 mm	21291	
8 mm	21292	



No. 21292



No. 21291

## Zinc-nickel coated flat hooks

Hook opening	Art.-No.	Price / each
17 mm	21294	



No. 21294

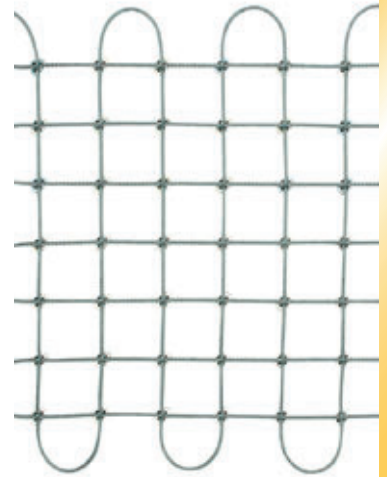

From the front: "Powernet".  
The meshes are screw-connected.

①

## Safety nets for overhead cable construction ①

### Description:

Knotless, high-tenacity polypropylene safety net. Square mesh, edged all round with approx. 12 mm, 30-kN rope. Thimbles on the four corners and every 2.50 m along the sides.

Mesh size	Material dia.	Colours	Art.-No.	Price / m <sup>2</sup>
100 mm	4 mm	● Green	2002-100	
100 mm	5 mm	● Green	2003-100	
300 mm	5 mm	● Black	2003-300	

### Surcharge for small quantities:

Nets under 1 m<sup>2</sup>: upon request  
 Nets under 5 m<sup>2</sup> + 100% per net  
 Nets under 10 m<sup>2</sup> + 35% per net  
 Nets under 20 m<sup>2</sup> + 20% per net

*The surcharge is based on the size of a single net, and not on the total order.*

● = 01 = green      ● = 06 = black

Example of product number: 2003-100-01  
 Specification      Mesh size      Colour

## "Powernet" wire rope netting

This is the screw-connected design version and is therefore of the greatest strength. For conditions subject to extreme stress: as netting for blasting operations, or protection against falling rocks and loosened tree-trunks, etc.

### No. 4000-100

Wire rope netting made of galvanised steel wire ropes approx. 6 mm dia.  
 Square mesh 100 x 100 mm.

Price on request

### No. 4001-150

Wire rope netting made of galvanised steel wire ropes approx. 8 mm dia.  
 Square mesh 150 x 150 mm.

Price on request

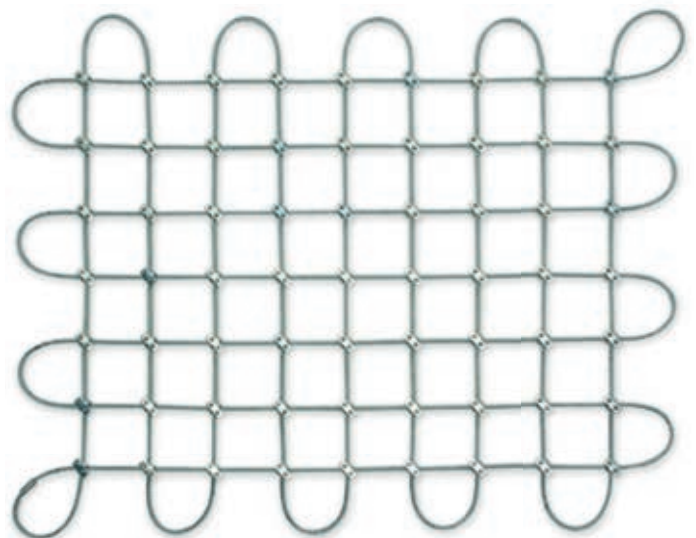

"Powernet" shown from the back.



Eye with thimble    Female thread fitting    Thread fitting    Eye fitting    Forked fitting

Dralo® – a particularly attractive wire rope net.



Dralo® used to secure the edges of a helicopter landing pad at a hospital in Meran.

## Area of use

Wire rope nets made from DRALO are used

- as horizontal nets to prevent loads from falling (e.g. helicopter landing place)
- as vertical nets among others for side protection (guardrail nets)

For these applications we do have a general building authority permit certified by DIBT.

Dralo® nets are available in the following versions:

- Galvanised steel wire with aluminium clips
- 1.4401 high-grade steel wire with high-grade steel clips V2A
- 1.4401 high-grade steel wire with aluminium clips

### Installation/net finishes:

Dralo® nets are made with a square mesh. Due to the way the mesh is laid, every other row finishes in a loop all the way round the edge. These loops are used to fasten the net, either using a steel edging wire drawn through them and then tightened, or by hanging the loops directly in rings.

Please request a detailed offer for the many installation possibilities.

**Important:** If installing nets yourself, take care that they are not trapped or stretched. Trapped or stretched nets are noticeably weaker around the edges due to the resulting shear forces and/or additional tension.

Please request a detailed quotation for your particular area of application.

**All nets fitted with loops all round. They can also be supplied with rope surround on request. Square mesh.**

**When ordering, please state whether nets should be galvanised or stainless steel version.**

**Prices on request.**

### Weight-bearing capacity/breaking strengths

When used for safety or stop nets, it must be borne in mind that Dralo® creates a rigid net that has a lower, more uneven energy absorption than nets in plastic cord. Breaking strengths for the steel wire used correspond to the standard tables.

**The lateral displacement force where the wires cross is highly improved to 80 kg - 350 kg!**

Critical factors in an overall assessment are:

- fixing method and
- the total size of the nets.

The maximum width of individual nets without connective fastenings is 5 m; their weight should not exceed 300 kg. These nets are fitted with loops all round, allowing them to be fitted almost anywhere. A rope surround can also be supplied on request. The mesh is of square configuration.

When ordering, please state whether the nets should be the galvanised or stainless steel version.

Available mesh sizes in the table below.

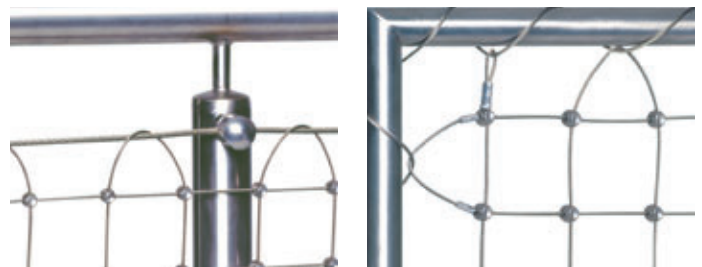

Mesh size in mm	25	50	75	100	125	150	175	200
Rope diameters								
1.5 mm ø	•	•	•	•	•	•	•	•
2.0 mm ø	•	•	•	•	•	•	•	•
3.0 mm ø		•	•	•	•	•	•	•
4.0 mm ø		•	•	•	•	•	•	•
5.0 mm ø			•	•	•	•	•	•



Wire rope net DRALO "XTreme" in test framework.

## Wire rope net type "DRALO Xtreme"

### To prevent objects from falling.

For extreme stress: e. g. as rockfall net in concrete works...

To test the load capacity drop tests were performed by the German Institute for Occupational Health and Safety for German Statutory Accident Insurance. For the tests DRALO nets with rope diameter of 6 mm and a mesh size of 100 mm were selected. A specially produced steel frame with a ring insert on 8 supports at 3 m high was used as a test bench. For the drop tests the test mass was caught without safety-related damage to the net or the absorber system. To reduce impact energy when catching the testing mass specially developed absorber systems were used.



Actual condition following the drop test, with triggered „absorbers“

Test body was an irregular-shaped boulder

Weight: 685 kg

Height of fall: 7.50 m

For extreme stress: e.g. as rockfall net in concrete works. Of course other forms are possible here too: Square, rectangle, oval...

The absorbers can be continuously adjusted to requirements.

### No. 4860-100

**Wire rope net** in galvanised steel wire rope approx. **6 mm ø**, **MW 100 x 100 mm**. Mesh of square configuration.

Price on request



## Synthetic ropes made of polypropylene, hemp-coloured.

For the most varied fields of application in the industrial and construction sector we offer you synthetic ropes in cables of 2 standard lengths.



No. 40201-08, 6 mm ø



No. 40204-08, 12 mm ø



No. 40208-08, 20 mm ø



No. 40212-08, 28 mm ø



Rope dia.	Weight	Min breaking st.	Cable length	Art.-No.	Price / cable
6 mm	17 g/m	590 daN	100 m	40201-08	
8 mm	30 g/m	1040 daN	100 m	40202-08	
10 mm	45 g/m	1530 daN	100 m	40203-08	
12 mm	58 g/m	1950 daN	100 m	40204-08	
14 mm	81 g/m	2690 daN	50 m	40205-08	
16 mm	103 g/m	3330 daN	50 m	40206-08	
20 mm	162 g/m	5120 daN	50 m	40208-08	
24 mm	234 g/m	7170 daN	50 m	40210-08	
28 mm	319 g/m	9440 daN	50 m	40212-08	



## Braided lines made of polypropylene, high tenacity, green.

Polypropylene braided lines are well proven and tested aids for fastening in the industrial and construction sector. We offer them in a practical make-up on a 100 m reel.



No. 35211-01, 3 mm ø



No. 35214-01, 6 mm ø



No. 35216-01, 10 mm ø



No. 35217-01, 12 mm ø



Rope dia.	Weight	Min breaking st.	Cable length	Art.-No.	Price / cable
3 mm	3 g/m	100 daN	100 m	35211-01	
4 mm	6 g/m	150 daN	100 m	35212-01	
6 mm	17 g/m	335 daN	100 m	35214-01	
8 mm	30 g/m	625 daN	100 m	35215-01	
10 mm	45 g/m	960 daN	100 m	35216-01	
12 mm	65 g/m	1330 daN	100 m	35217-01	

## Synthetic ropes made of polysteel, white with Huck-stripes

Rope dia.	Weight	Min breaking st.	Cable length	Art.-No.	Price / cable
9 mm	50 g/m	15 kN	220 m	21380R-02	
12 mm	74 g/m	30 kN	220 m	21370R-02	



## Isilink

### HUCK - Isilink

No limits to the possibilities for fixing and adjustment without metal components.

#### No. 38030

Isilink line in high tenacity polypropylene, 3 mm dia.,  
Breaking strain: 80 daN, Metres/reel: 1000 m

● Green

#### No. 38040

Isilink line in high tenacity polypropylene, 4 mm dia.,  
Breaking strain: 100 daN, Metres/reel: 600 m

● Blue

#### No. 38060

Isilink line in high tenacity polypropylene, 6 mm dia.,  
Breaking strain: 160 daN, Metres/reel: 500 m

● Red

#### No. 38080

Isilink line in high tenacity polypropylene, 8 mm dia.,  
Breaking strain: 290 daN, Metres/reel: 250 m

● Black

#### No. 38100

Isilink line in high tenacity polypropylene, 10 mm dia.,  
Breaking strain: 360 daN, Metres/reel: 150 m

● Hemp coloured

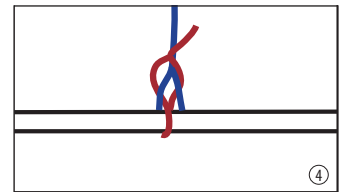
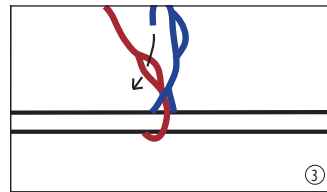
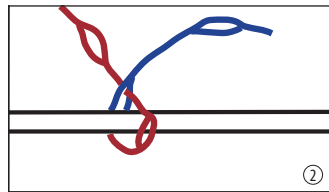
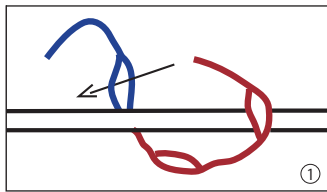

①–④ Simply cut off the desired length and weld together quickly with a small flame (from a match or cigarette lighter). Then place both ends in the openings provided and pull tight.

## Braided cord in high-strength polypropylene, 8-ply braided

Cords for industry, craft and DIY, particularly also for repairing and fastening nets.

Rope dia.	Weight	Min breaking st.	Reel length	Art.-No.	Price/reel
4.5 mm	7.5 g/m	260 daN	500 m	35203-01	
4.5 mm	7.5 g/m	260 daN	500 m	35203-02	
4.5 mm	7.5 g/m	260 daN	500 m	35203-03	
4.5 mm	7.5 g/m	260 daN	500 m	35203-04	
4.5 mm	7.5 g/m	260 daN	500 m	35203-05	
4.5 mm	7.5 g/m	260 daN	500 m	35203-06	
4.5 mm	7.5 g/m	260 daN	500 m	35203-07	
4.5 mm	7.5 g/m	260 daN	500 m	35203-08	



## Repair cord in high-strength polypropylene, 8-ply braided

Rope dia	Weight	Min breaking st.	Reel length	Art.-No.	Price/reel
4.5 mm	7.5 g/m	260 daN	25 m	35223-01	



## Scaffolding rope

#### No. 2013

Scaffolding rope in Polypropylene, white-blue, 2 m long, approx. 8 mm diameter, with clip, 4-ply with small loop



## Impermeable Tarpaulins

Impermeable tarpaulins as protection against wind and storm, dirt and dust. Environmentally friendly, recyclable and UV stabilised.



No. 340-025 HDPE woven tape, approx. 180 g/m<sup>2</sup>

No. 35001 - 35004 tarpaulin made of woven PP mesh, approx. 220 g/m<sup>2</sup>

### HUCK-tarpaulins

#### Standard sizes

Tarpaulins made of coated PP mesh, approx. 220 g per m<sup>2</sup>, and tape surround, 5 cm wide, with holes for attachment every 10 cm.

Size app.	Weight	Colours	Art.-No.	Price / each
3 × 4 m	220 g/m <sup>2</sup>	● Blue	35001-04	
4 × 5 m	220 g/m <sup>2</sup>	○ White	35002-02	
6 × 8 m	220 g/m <sup>2</sup>	● Blue	35003-04	
6 × 10 m	220 g/m <sup>2</sup>	○ White	35004-02	

Tarpaulin cover sheets with alum. Eyelets 100 cm apart, approx. 150 g/m<sup>2</sup>, with edged PE cord, UV stabilised. Tear resistance approx. 750N/5 cm

Size app.	Weight	Colours	Art.-No.	Price / each
6 × 10 m	150 g/m <sup>2</sup>	● Transparent	35101-025	
8 × 10 m	150 g/m <sup>2</sup>	● Transparent	35102-025	
10 × 12 m	150 g/m <sup>2</sup>	● Transparent	35103-025	
10 × 15 m	150 g/m <sup>2</sup>	● Transparent	35104-025	

#### Any size

**No. 340** Tarpaulin made of coated HDPE tape fabric, approx. 180 g per m<sup>2</sup>, seamed all round as well as eyelets 50 cm apart. Tear strength lengthwise and across: approx. 880 N/5 cm. Temperature resistance: - 40° to + 80°.

- Transparent

### HUCK-tarpaulins

#### In Rolls

Tarpaulin made of coated HDPE tape fabric, approx. 180 g per m<sup>2</sup>, seamed all round. With one weld seam. Tear strength lengthwise and across: approx. 880 N/5 cm. Temperature resistance: - 40° to + 80°.

Size app.	Weight	Colours	Art.-No.	Price / each
4 × 100 m	200 g/m <sup>2</sup>	● Transparent	34005-025	

#### Fastening

**No. 2126,**  
6 mm thick elastic stretch rope, attached

**No. 2130,**  
6 mm thick polyethylene rope, attached  
● Green

#### Surcharge for small quantities:

Nets under 1 m<sup>2</sup> +200% per net  
Nets under 5 m<sup>2</sup> +100% per net  
Nets under 10 m<sup>2</sup> +35% per net  
Nets under 20 m<sup>2</sup> +20% per net.

**The surcharge is based on the size of a single net, and not on the total order.**

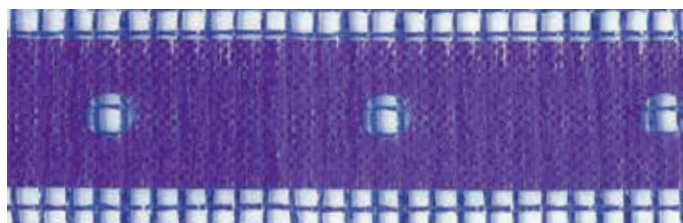

No. 35002-04 tarpaulin made of woven PP mesh, approx. 220 g/m<sup>2</sup>

## Air Permeable Nets / Covers

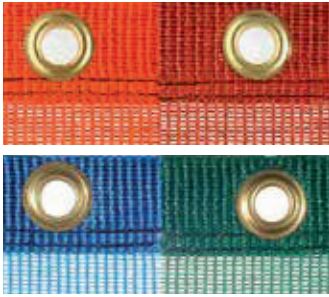

No. 720 ● orange / ● Terracotta, ● Blue / ● Green; polyethylene fabric, approx. 200 g/m<sup>2</sup>



No. 760 ● Black polyethylene fabric, approx. 240 g/m<sup>2</sup>



No. 775 ● Dark green polyethylene, flame resistant, approx. 320 g/m<sup>2</sup>



No. 775 ● silver / ● cream polyethylene (in silver. Flame resistant), approx. 320 g/m<sup>2</sup>



No. 775 ● Blue polyethylene fabric, flame resistant, approx. 320 g/m<sup>2</sup>



No. 790 ● Green polyester mesh, approx. 450 g/m<sup>2</sup>

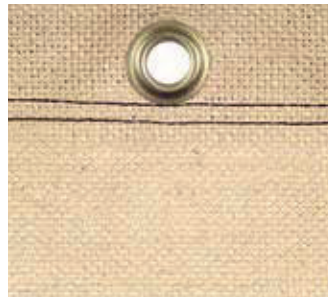

No. 795 ● Natural fibre tarpaulin approx. 450 g/m<sup>2</sup>

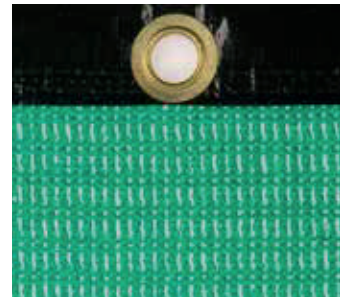

No. 785 ● Green high tenacity polypropylene, approx. 550 g/m<sup>2</sup>

## Air permeable plastic covers in any size per m<sup>2</sup>

Description*	Weight per m <sup>2</sup>	Colours	Shading	Art.-No.	Price/m <sup>2</sup>
Polyethylene	app. 200 g	● Light green ● Dark green ○ White ● Blue	50 : 50	720	
Polyethylene	app. 200 g	● Orange ● Red ● Terracotta ● Silver ● Cream	50 : 50	720	
Polyethylene	app. 220 g	● Dark green	90 : 10	765	
Polyethylene	app. 240 g	● Black	50 : 50	760	
Polyethylene	app. 320 g	● Dark green ● Blue ● Gray ● Silver (fire retardant)	90 : 10	775	
Polyethylene	app. 320 g	● Cream	90 : 10	775	
Polyestermesh	app. 450 g	● Green	50 : 50	790	
Natural fibre	app. 450 g	● Hemp (Natural fibre!)		795	
High-tenacity PP.	app. 550 g	● Green	50 : 50	785	

- = 010 = Green      ● = 03 = orange      ● = 08 = hemp
- = 015 = Dark Green      ● = 04 = blue      ● = 65 = gray
- = 025 = transparent      ● = 06 = black      ● = 66 = silver
- = 02 = white      ● = 07 = red      ● = 76 = terracotta
- = 86 = creme

Please add the required colour code to the product number .

Example of product number: 775-06

Specification      Colour

**The surcharge is based on the size of a single net, and not on the total order.**

### Surcharge for small quantities:

Nets under 1 m<sup>2</sup> +200% per net  
 Nets under 5 m<sup>2</sup> +100% per net  
 Nets under 10 m<sup>2</sup> +35% per net  
 Nets under 20 m<sup>2</sup> +20% per net.  
 The surcharge is based on the size of a single net, and not on the total order.

## Building Site Fencing

This type of fence can be set up in a few minutes. This high visibility barrier demarcates dangerous areas, thus protecting passers-by and personnel, at minimum cost. The material is UV-stabilised, rot-proof, air-permeable and can be used many times. The fence is supplied on roll.



No. 7001 with No. 2159

### No. 7001 Building-site security fence without posts

in rolls of 50 m length and 1 m height. Weight per roll: 10 kg, Weight per m<sup>2</sup>: approx. 200 g. Size of opening: 35 x 85 mm. Only available in rolls of 50 m x 1 m.

- Orange

### No. 7050 New building-site boundary fence,

made from air-permeable PE Raschel tape knitted fabric with polyester posts already incorporated, with steel tips.

- Orange

#### Description 7050:

**Posts:** 1.10 m long, 12 mm dia.  
**Colour:** Orange  
**Distance between posts:** 2,50 m  
**Fence length:** 25 m  
**Net:** 85 cm high  
**Weight (incl. posts):** approx. 4 kg

### No. 2159, Support post,

made from T-iron, galvanised, 20 x 20 x 3 mm, pointed at one end, with 6 mm dia. transverse bolt, 130 cm high. For fencing no. 7001.

### No. 2159-1

Steel fence posts, galvanised, hooked at top, 1.30 m x 8 mm, pointed at one end, 130 cm high, for building site fencing no. 7001



No. 7050

No. 7001

No. 2159

No. 2159-1

## Site fence screen

### No. 7101

Site fence screen, knitted PE fabric approx. 150 g/m<sup>2</sup>, reinforced edging all round, additional corner reinforcement with 12 mm aluminium eyelet, size: 1.80 x 3.45 m, suitable for 1 site fence area,

- Dark Green ○ White ● Blue

### No. 7101P

Site fence screen, knitted PE fabric approx. 150 g/m<sup>2</sup>, reinforced edging all round, additional corner reinforcement with 12 mm aluminium eyelet, size: 1.80 x 3.45 m, suitable for 10 site fence areas, **pack of 10**

- Dark Green ○ White ● Blue





## More top quality products from HUCK



### Huck sports nets and ropes covering all ball games

In this special catalogue you will find nets for football, handball, volleyball, badminton and tennis as well as beach and fun games and every other type of sport imaginable. We will be pleased to send you this catalogue on request.

### Industrial nets - a world of nets for technology and the environment

Lifting, pulling, loading, covering, protecting, securing - in a technical world there is a world of nets. Scarcely any material meets the multiple demands of in company work as flexible and as cost effectively as the net. Order our special catalogue now.

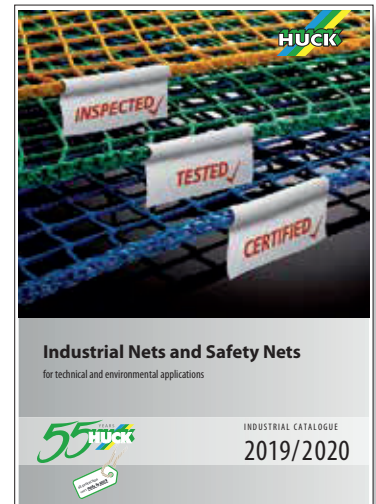

### Huck rope technology

We have extended our playground range again this year. The goods in this range such as climbing nets, swings, net bridges, rope ladders, climbing ropes and net sports equipment can be found in our catalogue 'Huck Rope Technology'. Please request this special catalogue from us.



# Index

- 
- A**  
Aluminium safety hooks ..... 16  
Aluminium scaffolding ..... 31  
Assembly request form ..... 20  
Assembly instructions on small safety nets ..... 47  
Attachment ties ..... 36
- B**  
Braided lines ..... 57  
Brick guardrail nets with Isilink Clips ..... 26  
Buckled straps ..... 29 and 30  
Building site fencing ..... 60
- C**  
Cargo nets ..... 49  
Clove hitch ..... 15  
Covers, air-permeable ..... 59  
Covers, impermeable ..... 58  
Cross ropes ..... 14
- D**  
Dome light safety system ..... 17  
Dralo® ..... 54  
Dust protection nets ..... 35-36
- F**  
Fall-arrest nets, flame-retardant ..... 48
- G**  
Grippa safety net hooks ..... 16  
Ground anchors ..... 45
- H**  
Hiring of safety nets ..... 18
- I**  
Information on safety nets ..... 5  
Isilink clips ..... 27  
Isilink ties ..... 36  
Isilink ..... 57
- J**  
Joining ropes ..... 14
- L**  
Load cables, polyester ..... 49  
Load-carrying nets ..... 49  
Load-transporting nets ..... 49-50
- M**  
Mahulan ..... 43  
Mining barrier nets ..... 48
- N**  
Net protection walls, ready-made ..... 31  
Net surround cords for safety and industrial nets ..... 44  
Netting covers for trailers ..... 51  
Netting suspension ..... 14-16
- O**  
Overhead cable construction nets ..... 53  
Overlay nets ..... 11  
Overlay panels ..... 10-11
- P**  
Pallet rack nets ..... 46  
Powernet wire rope netting ..... 53
- R**  
Ready made net protection walls ..... 31  
Repair Cord ..... 61  
Ropes ..... 56-57
- S**  
Safety and industrial nets ..... 44  
Safety and industrial nets according to material strength ..... 42-43  
Safety and industrial nets, accessories ..... 44-45  
Safety and industrial nets, metre lengths ..... 44  
Safety and industrial nets, technical details ..... 39-41  
Safety information, guardrail nets ..... 38  
Safety net installation information ..... 20-21  
Safety nets with flame-retardant finish ..... 48
- Safety nets with suspension ropes ..... 8  
Safety nets, diamond mesh ..... 9  
Safety nets, information ..... 5  
Safety nets, square mesh ..... 6-8  
Safety-net assembly ..... 18-19  
Scaffolding protection netting ..... 35-36  
Scaffolding protection tarpaulins ..... 37  
Scaffolding protection tarpaulins, flame retardant ..... 37  
Scaffolding rope ..... 56  
Side protection netting ..... 32-33  
Side protection nets with buckled straps ..... 30  
Side protection netting ..... 34  
Side protection netting, any size ..... 29  
Side protection netting, standard sizes ..... 28  
Site fence screen ..... 60  
Small nets ..... 23  
Snap hooks ..... 16  
Storage sacks ..... 16  
Suspension ropes ..... 14  
Synthetic ropes ..... 17 and 56
- T**  
Tarpaulins for trailers ..... 52  
Tarpaulins ..... 58-59  
Technical details, safety and industrial nets ..... 39
- W**  
Weights for safety and industrial nets ..... 44  
Wire rope nets ..... 53-55  
Wire rope nets type "DRALO Xtreme" ..... 55  
Work-platform nets ..... 24-25

